



Full Control at Your Finger Tips

UTAdvanced[®]

***Digital Indicating Controllers
UT55A/UT52A/UT35A/UT32A***

***Program Controllers
UP55A/UP35A***

***Digital Indicator with Alarms
UM33A***

Bulletin 05P01A01-01EN

www.utadvanced.com

INTRODUCING THE **UTAdvanced**®

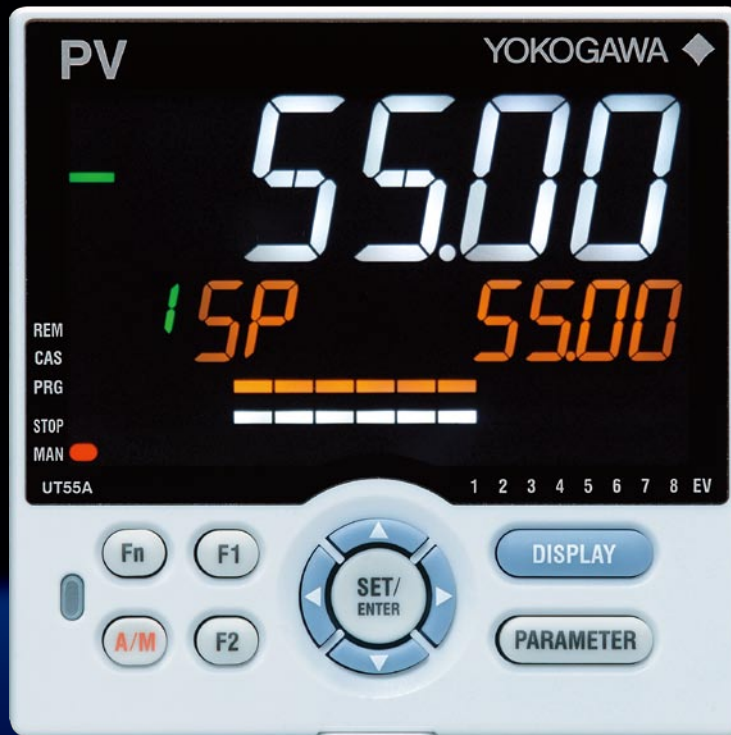

Balancing Simplicity and Power

The UTAdvanced was designed as a result of knowledge obtained in Yokogawa's fifty plus years of experience in the control market. Significant changes in the market are setting the tone for the future and Yokogawa will be leading the way meeting the challenging needs of the control segment. Balancing an easy to use controller with the power to handle your most challenging applications, that's the UTAdvanced.



features

Advanced Control

PID Control — 8 Built-in Control Modes
— 8 Built-in Control Types

Ladder Sequence Control

Fuzzy Logic Control

Simplicity

Bright & Easy to Read Active Color LCD Display
Scrolling Text

Navigation Guide & Navigation Keys

Programmable Function Keys

User Settable Default Values

Multiple Language Support

Compact Design

Networking

Ethernet (Modbus/TCP)

RS-485 (Modbus/RTU, Peer to Peer, Coordinated Operation, PC-Link)

Open Network (PROFIBUS-DP, CC-Link, DeviceNet)

Reliability

3 Year Warranty *Note 1

RoHS/WEEE

NEMA4*Note 2/IP56 Front Panel



CSA C22.2 61010-1

172608



UL61010-1



Note 1 : The 3 year warranty extends 36 months after shipment from our factory.

Note 2 : Hose down test only.



Advanced Control

8 Built-in Control Modes

The control mode allows easily configuring settings and making changes with parameters.

- Single-loop control
- Cascade primary-loop control
- Cascade secondary-loop control
- Cascade control
- Loop control for backup
- Loop control with PV switching
- Loop control with PV auto-selector
- Control with PV-hold function

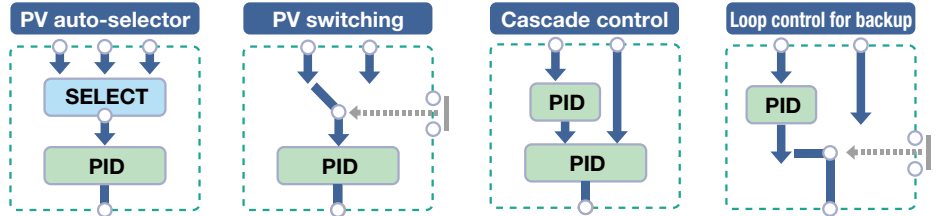

8 Built-in Control Types

- PID control
- ON/OFF control (1 point of hysteresis)
- ON/OFF control (2 points of hysteresis)
- Two-position, two-level control
- Heating/cooling control
- Sample PI control
- Batch PID control
- Feedforward control

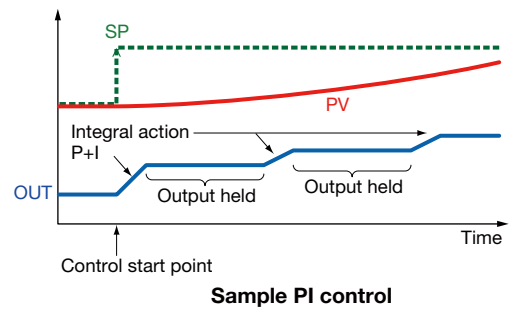
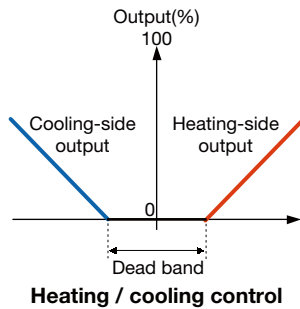

For the correspondence between the above control mode and control types for each model, please refer to the specifications of each model.

Ladder Sequence Control

With built-in ladder sequence control, the range of applications are dramatically increased. This feature is standard in all the UTAdvanced controllers (except UM33A). The ladder sequence control function can replace a small PLC required by the application. Sequence control and PID control can be performed simultaneously.

- Monitoring and control of external machinery
Eg. Lamps, switches, timers
- Solve digital input / output logic functionality easily.
Number of basic instruction types : 13
Number of application instruction types : 73

Name	Symbol
Load	
Set	
Timer	
Counter	
Compare	
Logic	
Data transfer	
High selector	
Temperature correction	

* LL50A Parameter Setting Software (sold separately) is required to build functions.

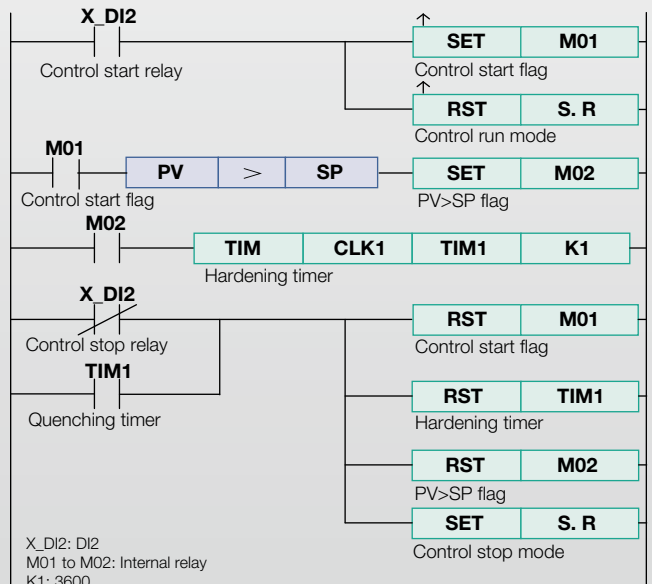
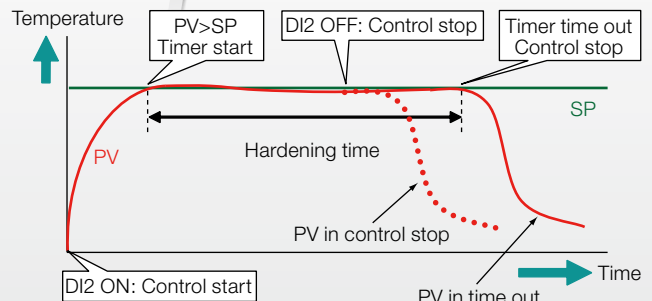

Application Examples of Ladder Sequence Program

Alarm Sequence Control Circuits Can be Reduced

The ladder sequence program is built in the UTAdvanced as standard. The ladder sequence function enables monitoring and controlling peripheral devices such as relays, thus making it possible to reduce costs.

Conventional

Alarm action was built by a sequence control circuit (relay, timer, etc.) outside of the controller.

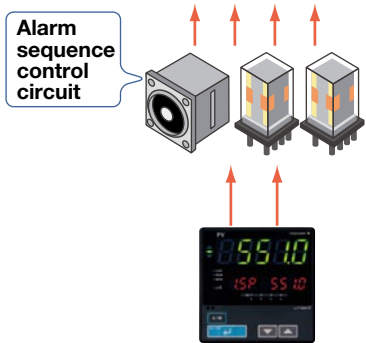

UTAdvanced

Alarm action is built by the ladder sequence program inside the UTAdvanced, thus making it possible to reduce costs.



Example: Alarm annunciator

Action explanation

- Lamp blinks when alarm occurs
- Lamp turns on by acknowledgment when alarm is on
- Lamp turns off by acknowledgment when alarm is off

Alarm acknowledgment by function key



Time Chart

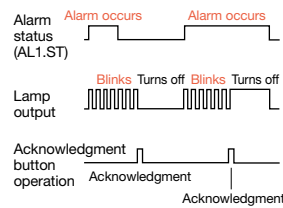

Alarm Ladder Sequence Program

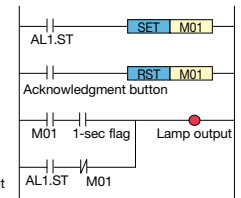

Host System Load is Reduced

Conventional

Action: Various types of analog data were captured into the host system (PLC, etc.) and calculated, and the results were processed by the field controller for control via a command.



UTAdvanced



Merit The UTAdvanced with up to 4 analog inputs* enables various types of analog data to be captured directly into the controller and calculated by the ladder program, thus reducing the system-building load of the host.

Fuzzy Logic

SUPER Function suppresses overshoot

The field-proven **SUPER** function utilizes a built-in operator experience and fuzzy theory to deliver fine control and suppress overshoot.

- When wishing to suppress overshoot
- When wishing to reduce the startup time
- When load changes are significant
- When setpoint is changed frequently

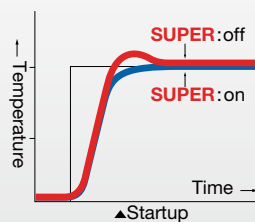

Fuzzy Logic

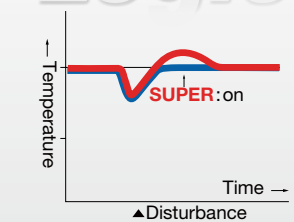
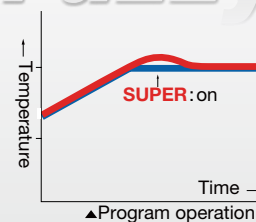

SUPER2 Function suppresses hunting

The new **SUPER2** function utilizes a built-in operator experience and modern control theory to deliver fine control and suppress hunting.

Effect 1: Material change or load change with the same PID.

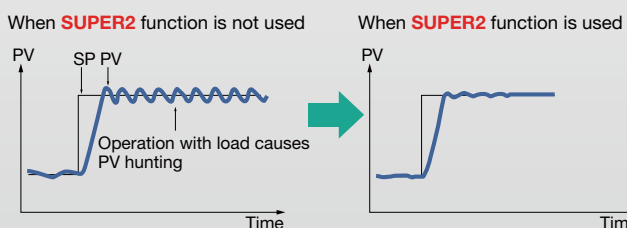

Effect 2: Setpoint (SP) change with the same PID.

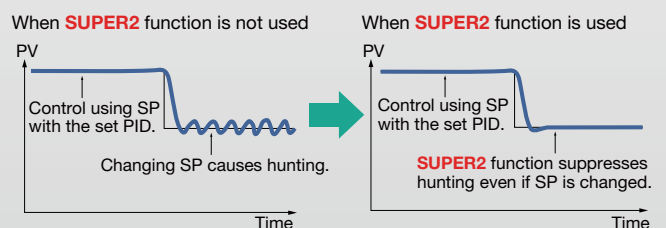



Simplicity

Digital Indicating Controller UT55A / UT52A / UT35A / UT32A

Bright & Easy to Read Active Color LCD Display

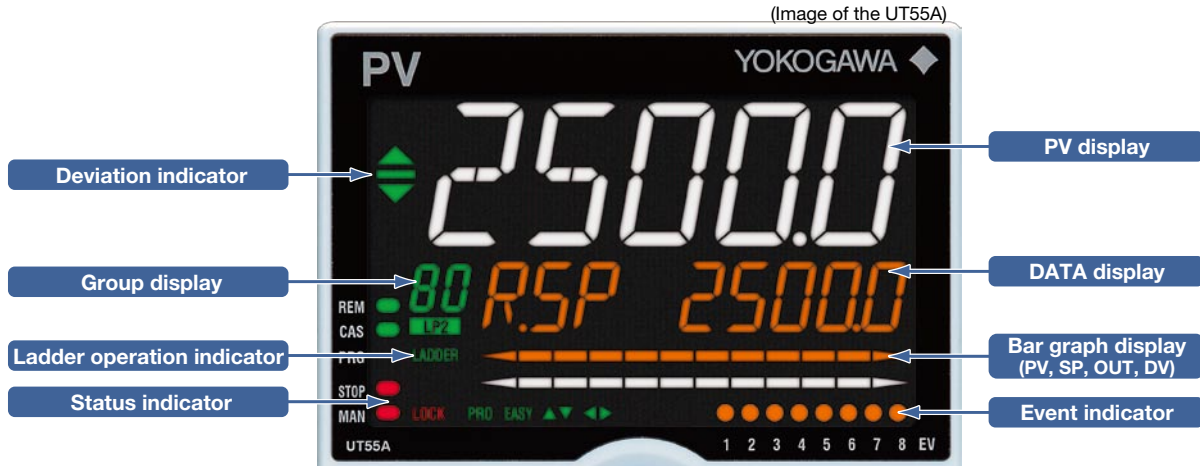

Optimal Display



The controller menus and layout are adjusted in accordance with the level (EASY, STD, PRO) of information required by the user. If simple temperature or level control is needed, then select the easy configuration. Very sophisticated applications are no problem for the UTAdvanced. Just select the PRO setting and make use of the additional functionality shown in this mode. Advanced applications can be programmed in the PRO setting and then changed back to the easy setting to lock out functions not required by operators.

Active Color LCD Display

With Yokogawa's active color display you can instantly tell, at a glance, the status of your process.

Alarm Status : Active color display changes from white (normal) to red (alarm).

Deviation Status : Color changes based on a PV deviation from SP.

User-defined Color : Choose between white or red display for constant readings.



Compact Design

The 65-mm depth of the controller reduces the constraints on installation location.

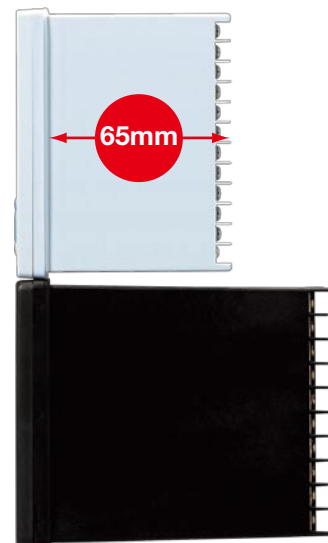

Program Controller UP55A / UP35A

Versatile Color LCD Display

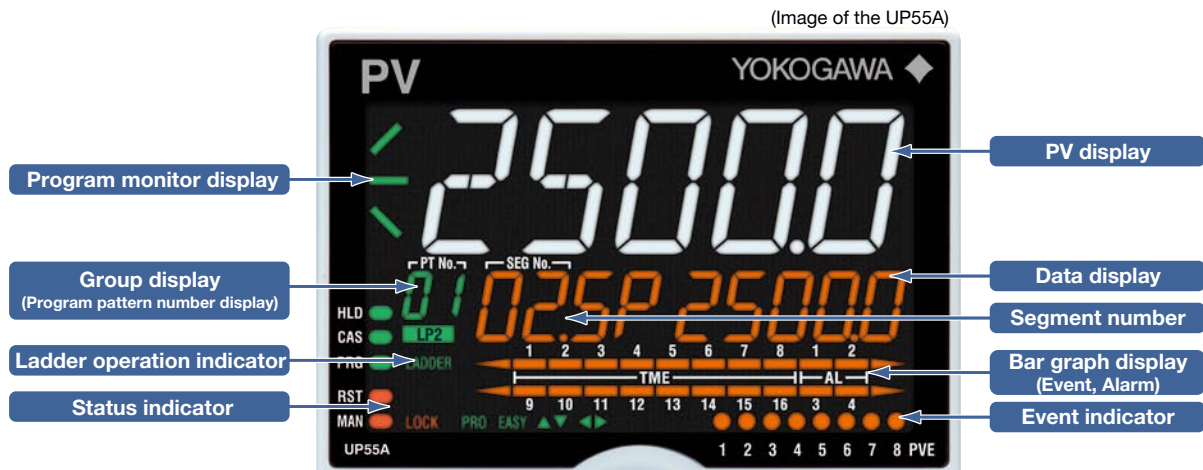

Operation Displays of the Program Controller

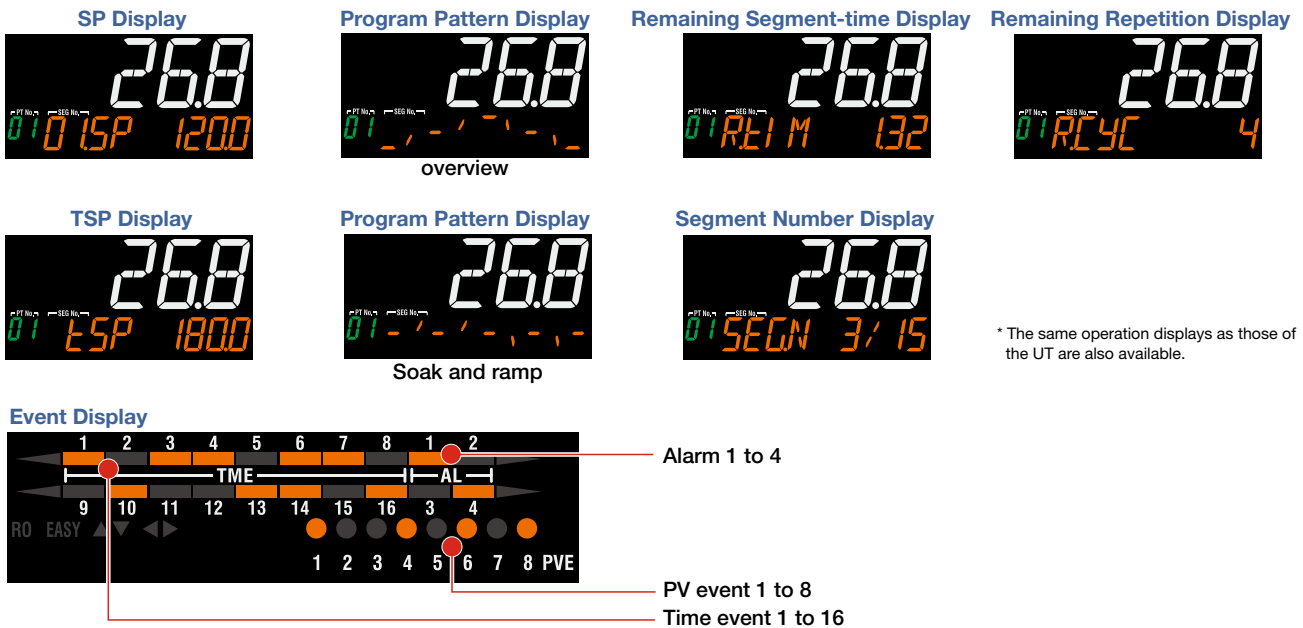

Functions of the Program Controller

Fast-forwarding of program operation

Use this function when checking the program pattern setting. Only times of segments and time events can be faster.

Program pattern-2 retransmission

The controller can serve as a program pattern generator.

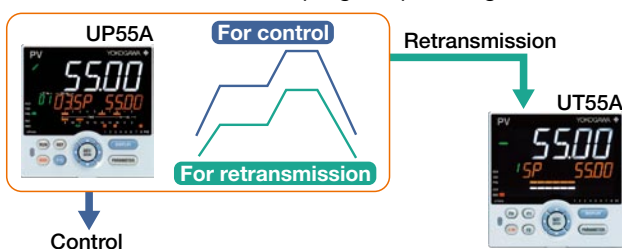

Synchronized program operation

If the progress of the operation of one unit is faster, the program operation can be forcibly stopped by digital input when switching between segments. Thus, synchronized program operation can be performed.

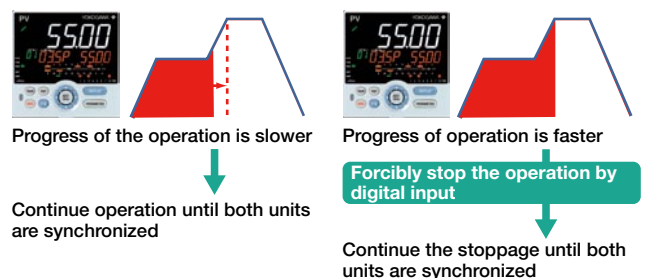



Simplicity

Easy Operation Map, Navigation Guide and Navigation Keys

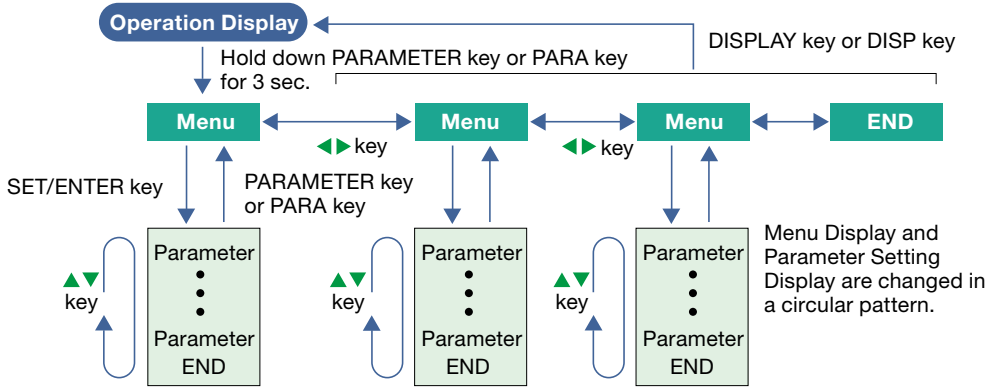

The parameter groups can be switched using ◀, ▶ keys.

The navigation keys is an intuitive method to navigate the controller's configuration menus and setting its various menus. Navigation arrows even tell you what button to push next.

Programmable Function Keys

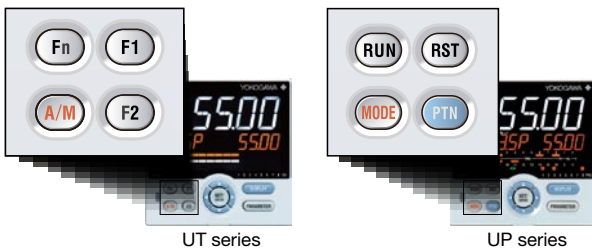

It is easy to assign frequently used functions, such as the operation mode switch, Run/Stop, program pattern selection, Remote/Local, alarm latch release, and PID parameter display. The function of an external switch can also be assigned to the front panel key in conjunction with a ladder sequence program.

Scrolling Text



The UTAdvanced is equipped with a scrolling text feature that fully lists the parameter being modified. There is no guessing what parameter you are looking at. It is possible to turn off scrolling text function.

Multiple Language Support

Example : TARGET SET POINT

German
Sollwert



French

Valeur de consigne



Spanish

Punto de ajuste objetivo



The UTAdvanced is fluent in multiple languages—English, Spanish, French, and German. The use of the UTAdvanced by local language operators is not an obstacle.

User Settable Default Values



Parameter values (SP, P, I, D, ALM1, etc.) configured by the user can be stored in the controller as the default values. LL50A Parameter Setting Software (sold separately) is required. Even if a parameter set value is accidentally changed, it can be restored to the original value with a simple operation.



Networking

Communication Functions

A network function is built into the back panel of the controller to make wiring simple.



- Ethernet
- RS-485
Modbus (RTU/ASCII), Peer to Peer, Coordinated, PC-Link
- Open Network
(PROFIBUS-DP, CC-Link, DeviceNet)



Modbus/TCP

Modbus TCP/IP, a protocol that allows the controller to connect to any Ethernet network and have the ability to exchange data with the computers or devices on that network.

- Allows control devices to be integrated into an application simply.
- Works with any Modbus TCP/IP compliant software.
- Support for Modbus function codes 03, 06, 08 & 16.
- Gateway function allows RS-485 Modbus devices to communicate via Ethernet.
- Reduced labor costs in wiring and setup of a communications network.
- Physical layer : 10 BASE-T/100 BASE-TX
- Max. number of connection : 2

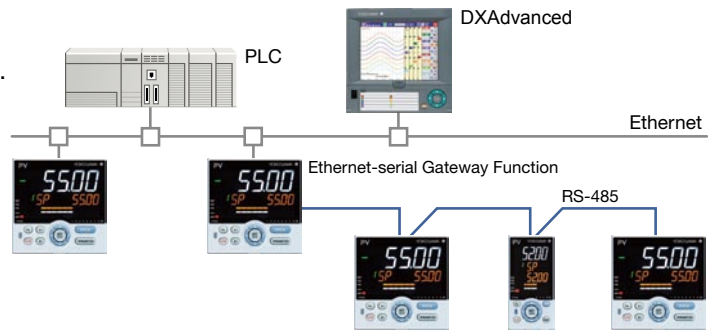

Modbus/RTU

The data of UTAdvanced (slave units) can be displayed and saved on the DXAdvanced using the Modbus RTU function.

Modbus master

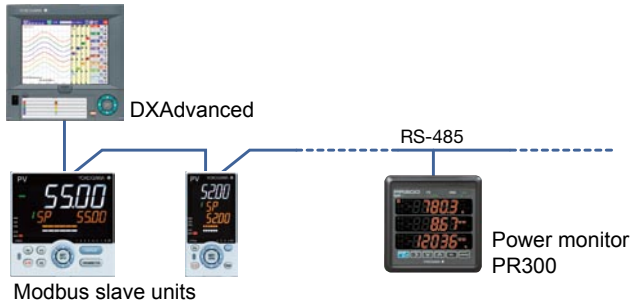

Peer to Peer

The use of the ladder sequence program makes it possible to exchange analog data and status data between communication-capable UTs.

Example: A UT in which an input error occurs sends a signal to another UT to enable that UT switch to MAN operation, thus shifting the whole system into a safe mode. In such a case, the safety mechanism can be built into the UT Advanced and is not required in the host system.

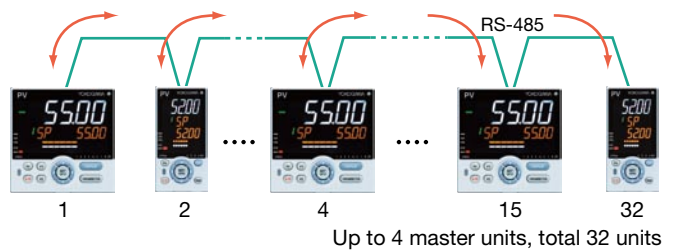

Coordinated Operation

In coordinated operation, a single UTAdvanced controller is used as a master controller and multiple UTAdvanced or other UT digital indicating controllers as slave controllers. The slave controllers are operated in accordance with the actions of the master controller.

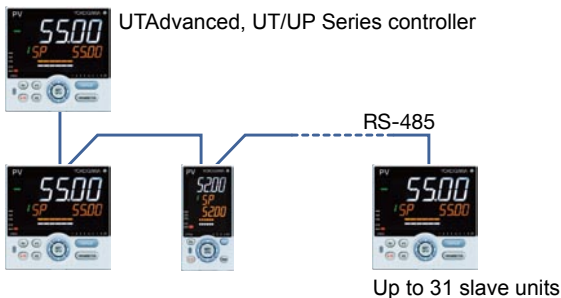

Open Network (PROFIBUS-DP, CC-Link, DeviceNet)

Embedded open networks will provide direct connection to PLC's.

- Reads data from UTAdvanced
- Writes parameter setting value to UTAdvanced

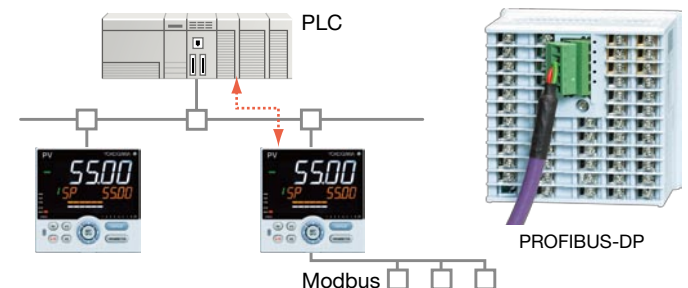

PC-Link

A protocol used for communicating with a general-purpose personal computer, or UT link module and serial communication module of FA-M3R (range-free controller).

- FA-M3R, Daqstation and DXAdvanced are registered trademark of Yokogawa Electric Corporation.
- Ethernet is a registered trademark of Xerox Corporation.
- Modbus is a registered trademark of AEG Schneider Automation Inc.
- PROFIBUS-DP is a registered trademark of PROFIBUS User Organization.
- CC-Link is a registered trademark of CC-Link Partner Association (CLPA).
- DeviceNet is a registered trademark of Open DeviceNet Vender Association, Inc.



Product line-up

Digital Indicating Controller UT55A / UT52A / UT35A / UT32A



Model		UT55A	UT52A	UT35A	UT32A	
Size	1/4 DIN	✓	—	✓	—	
	1/8 DIN	—	✓	—	✓	
	Depth from the panel surface (mm)	65	65	65	65	
Control Scan Period	(msec)	Choice 50/100/200	Choice 50/100/200	200	200	
Display Function	Number of PV Display Digits	5	5	5	5	
	Active Color PV Display Function	✓	✓	✓	✓	
	Guide Scroll Display Function	✓	✓	✓	✓	
	Message Display Function	✓	✓	✓	✓	
	Bar graph display (Number)	✓ (2)	✓ (2)	✓ (1)	✓ (1)	
PV Input Indication Accuracy	(% of F.S.)	0.1	0.1	0.1	0.1	
PV Input Type	TC	✓	✓	✓	✓	
	RTD (3-wire)	✓	✓	✓	✓	
	RTD (4-wire)	✓	✓	—	—	
	mV, V	✓	✓	✓	✓	
	mA	✓	✓	✓	✓	
Number of Analog Inputs	Standard (Maximum)	1 (4)	1 (2)	1	1	
Number of SPs (PIDs)	Maximum	8	8	4	4	
Number of Control Modes	Maximum	8	8	1	1	
Number of Control Types	Maximum	8	8	5	5	
Control Output	Type	Relay Contact Output, Voltage pulse output, Current output	✓	✓	✓	✓
	Algorithm	ON/OFF	✓	✓	✓	✓
		PID (Continuance, Time Proportion)	✓	✓	✓	✓
		Position proportional	✓	✓	✓	✓
		Heating / cooling	✓	✓	✓	✓
Number of Analog Outputs	Standard (Maximum)	2 (3)	2 (3)	2	2	
Number of Digital Inputs	Standard (Maximum)	3 (9)	3 (5)	2 (7)	2 (4)	
Number of Alarms		8	8	4	4	
Number of Digital Outputs	Standard (Maximum)	3 (18)	3 (5)	3 (8)	3 (5)	
Communication	RS-485 communication (Maximum)	✓ (2)	✓ (1)	✓ (1)	✓ (1)	
	Ethernet communication	✓	—	✓	—	
	Open Network (CC-Link/PROFIBUS-DP /DeviceNet)	✓	—	✓	—	
Various Function	Quick Setting Function	✓	✓	✓	✓	
	Split Computation Output Function	✓	✓	—	—	
	Ratio and Square Root Extraction Function	✓	✓	—	—	
	Remote SP Function	✓	✓	—	—	
	24 V DC Loop Power Supply Function	✓	✓	✓	✓	
	Heater Break Alarm Function	✓ (Standard type)	✓ (Standard type)	✓ (Standard type or Heating/cooling type)	✓ (Standard type or Heating/cooling type)	
Ladder Sequence Function	(Number of max. steps)	✓ (500)	✓ (500)	✓ (300)	✓ (300)	
Other Specifications	Power Supply	AC100 V to 240 V	✓	✓	✓	✓
		AC/DC 24 V	✓	✓	✓	✓
	Configuration Tool	Dust and waterproof Level of Front Panel	NEMA4*1 (IP56)	NEMA4*1 (IP56)	NEMA4*1 (IP56)	NEMA4*1 (IP56)
		Via Light-loader Communication	✓	✓	✓	✓
		Via Maintenance Port Communication	✓	✓	✓	✓
	Via RS-485/Ethernet communication	✓ / ✓	✓ / —	✓ / ✓	✓ / —	

The table above includes specifications of the standard models only.

* 1: Hose down test only.

Input Range

Input type	
TC	K, J, T, B, S, R, N, E, L, U, W PL-2, PR20-40, W97Re3-W75Re25
RTD	JPt100, Pt100
DC Voltage	0.4 to 2.0 V, 1.0 to 5.0 V, 0.0 to 2.0 V, 0 to 10 V, -10 to 20 mV, 0 to 100 mV
DC Current	4 to 20 mA, 0 to 20 mA

Program Controller UP55A / UP35A, Digital Indicator with Alarms UM33A



Model		UP55A	UP35A	UM33A	
Size	1/4 DIN	✓	✓	—	
	1/8 DIN	—	—	✓	
	Depth from the panel surface (mm)	65	65	65	
Control Scan Period	(msec)	Choice 100/200	200	Choice 50/100/200	
Display Function	Number of PV Display Digits	5	5	5	
	Active Color PV Display Function	✓	✓	✓	
	Guide Scroll Display Function	✓	✓	✓	
	Message Display Function	✓	✓	✓	
	Bar graph display (Number)	✓ (2)	✓ (1)	—	
PV Input Indication Accuracy	(% of F.S.)	0.1	0.1	0.1	
PV Input Type	TC	✓	✓	✓	
	RTD (3-wire)	✓	✓	✓	
	RTD (4-wire)	✓	—	—	
	mV, V	✓	✓	✓	
	mA	✓	✓	✓	
Number of Analog Inputs	Standard (Maximum)	1 (4)	1	1	
Number of SPs (PIDs)	Fixed	8	4	—	
Number of Control Modes	Maximum	5	1	—	
Number of Control Types	Maximum	4	4	—	
Control Output	Type	Relay Contact Output, Voltage pulse output, Current output	✓	✓	—
	Algorithm	ON/OFF	✓	✓	—
		PID (Continuance, Time Proportion)	✓	✓	—
		Position proportional	✓	✓	—
		Heating / cooling	✓	✓	—
Number of Analog Outputs	Standard (Maximum)	2 (3)	2	1	
Number of Digital Inputs	Standard (Maximum)	8 (9)	3 (8)	2	
Number of Program Patterns	Standard (Maximum)	30	2 (4)	—	
Number of Programs	Standard (Maximum)	300	20 (40)	—	
Number of Segments per Pattern	Standard (Maximum)	99	10	—	
Number of PV Events	(Per segment)	8	2	—	
Number of Time Events	(Per segment)	16	4	—	
Number of Alarms	Maximum	8	2	8	
Number of Digital Outputs	Standard (Maximum)	8 (18)	3 (8)	3 (9)	
Communication	RS-485 communication (Maximum)	✓ (2)	✓ (1)	✓ (1)	
	Ethernet communication	✓	✓	—	
	Open Network (CC-Link/PROFIBUS-DP /DeviceNet)	✓	✓	—	
Various Function	Quick Setting Function	✓	✓	✓	
	Split Computation Output Function	✓	—	✓	
	Ratio and Square Root Extraction Function	✓	—	✓ *3	
	Remote SP Function	✓	—	✓	
	24 V DC Loop Power Supply Function	✓ *2	✓ *2	✓	
	Heater Break Alarm Function	✓ (Standard type)	✓ (Standard type)	—	
Ladder Sequence Function	(Number of max. steps)	✓ (500)	✓ (300)	—	
Other Specifications	Power Supply	AC100 V to 240 V	✓	✓	✓
		AC/DC 24 V	✓	✓	✓
	Configuration Tool	Dust and waterproof Level of Front Panel	NEMA4*1 (IP56)	NEMA4*1 (IP56)	NEMA4*1 (IP56)
		Via Light-loader Communication	✓	✓	✓
		Via Maintenance Port Communication	✓	✓	✓
Via RS-485/Ethernet communication	✓ / ✓	✓ / ✓	✓ / —		

The table above includes specifications of the standard models only.

* 1: Hose down test only.

* 2: This function is available when the /L4 or /LC4 option is specified with the detailed code model.

* 3: Square root extraction available



Product line-up

Digital Indicating Controller UT55A / UT52A (Standard model)



Main Features

- Up to 4 analog inputs available
- 3 alarm independent common terminals available as standard
- Ladder sequence programs can be built
- Simple operation
- Up to 18 DOs (combinations available)
- Multiple language operation manual (Japanese, English, German, French, Spanish, Chinese, and Korean) available. Please specify the desired language when ordering.

External Dimensions

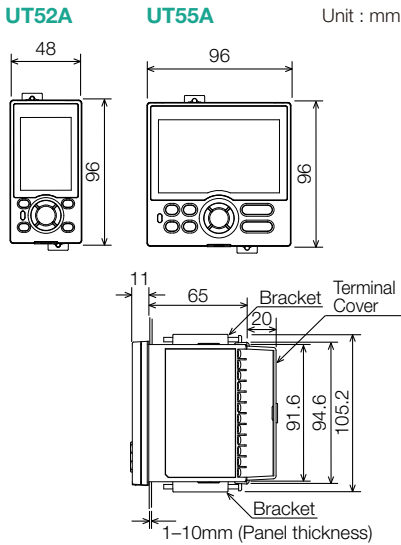

Model and Suffix Codes

Model	Suffix code	Optional suffix code	Description
UT55A			Digital Indicating Controller (provided with retransmission output or 15 V DC loop power supply, 3 DIs, and 3 DOs) (Power supply: 100-240 V AC)
Basic control	-0		Standard type
	-1		Position proportional type
	-2		Heating / cooling type
Functions (* 1)	0		None
	1		Remote (1 additional aux. analog input, 6 additional DIs, 5 additional DOs, and RS-485 communication (Max.19.2 kbps, 2-wire / 4-wire) (* 2)
	2		Remote (1 additional aux. analog input, 1 additional DI, and RS-485 communication (Max.19.2 kbps, 2-wire / 4-wire) (* 2)
	3		5 additional DIs and 5 additional DOs
	4		Remote (1 additional aux. analog input and 1 additional DI)
	5		Remote (1 additional aux. analog input, 6 additional DIs, and 5 additional DOs)
	6		5 additional DIs and 15 additional DOs
	7		3 additional aux. analog inputs and 3 additional DIs
Open networks	0		None
	1		RS-485 communication (Max.38.4 kbps, 2-wire / 4-wire)
	2		Ethernet communication (with serial gateway function)
	3		CC-Link communication (with Modbus master function)
	4		PROFIBUS-DP communication (with Modbus master function)
Display language (* 7)			DeviceNet communication (with Modbus master function)
		-1	English
		-2	German
		-3	French
Case color		-4	Spanish
		0	White (Light gray)
		1	Black (Light charcoal gray)
		-00	Always "-00"
Options		/DR	Additional direct input (TC and 3-wire / 4-wire RTD) and DC current to Remote (1 additional aux. analog input, 1 DI to be deleted (* 3))
		/LP	24 V DC loop power supply (* 4)
		/HA	Heater break alarm (* 5)
		/DC	Power supply 24 V AC / DC
		/CT	Coating (* 6)

- * 1: When "1" or "6" is specified for the Functions code, only "0" can be specified for the Open networks code.
 * 2: When the /LP option is specified, the RS-485 communication is 2-wire system.
 * 3: When any of "1," "2," "4," "5," or "7" is specified for the Functions code, the /DR option can be specified.
 * 4: /LP option can be specified in the combination of Functions code (any of "0," "2," "3" or "4") and Open networks code (any of "0" or "1"). Additionally, /LP option can be specified in the combination of Functions code "1" and Open networks code "0".
 * 5: When "-0" is specified for the Basic control code, the /HA option can be specified.
 * 6: When the /CT option is specified, the UT55A does not conform to the safety standards (UL and CSA) and CE marking.
 * 7: English, German, French, and Spanish can be displayed as the guide display.

Model	Suffix code	Optional suffix code	Description
UT52A			Digital Indicating Controller (provided with retransmission output or 15 V DC loop power supply, 3 DIs, and 3 DOs) (Power supply: 100-240 V AC)
Basic control	-0		Standard type
	-1		Position proportional type
	-2		Heating / cooling type
Functions	0		None
	1		Remote (1 additional aux. analog input, 1 additional DI, and RS-485 communication (Max. 38.4 kbps, 2-wire))
	2		Remote (1 additional aux. analog input and 1 additional DI)
Open networks	0		2 additional DIs and 2 additional DOs
			None
Display language (* 5)		-1	English
		-2	German
		-3	French
		-4	Spanish
Case color		0	White (Light gray)
		1	Black (Light charcoal gray)
		-00	Always "-00"
	Options		/DR
		/LP	24 V DC loop power supply (* 2)
		/HA	Heater break alarm (* 3)
		/DC	Power supply 24 V AC / DC
		/CT	Coating (* 4)

- * 1: When "2" is specified for the Functions code, the /DR option can be specified.
 * 2: When "-0" or "-1" is specified for the Basic control code, the /LP option can be specified.
 * 3: When "-0" is specified for the Basic control code, the /HA option can be specified.
 * 4: When the /CT option is specified, the UT52A does not conform to the safety standards (UL and CSA) and CE marking.
 * 5: English, German, French, and Spanish can be displayed as the guide display.

Popular Universal I/O and Auto-Tuning Function Available

Universal Input

Select from TC, RTD, mV / DC voltage and DC current.
 (Direct connection : No shunt resistor required)

The input type and range is user selectable via the front panel or by using the LL50A parameter setting software.

- 0.1% Indication Accuracy
- Connect up to two 2-wire transmitters simultaneously

All instruments have a 15 V Loop Power Supply (15 V LPS) for a transmitter.

In addition, a 24 V LPS is also available simultaneously for some instruments as optional function.

Applicable models for 24 V LPS: UT55A, UT52A

Thermocouple Type	K, J, T, B, S, R, N, E, L, U, W, PL-2, PR20-40, W97Re3-W75Re25
RTD Type	Pt100, JPt100
DC Voltage Input	0.4 to 2V, 1 to 5V, 0 to 2V, 0 to 10V, -10 to 20mV, 0 to 100mV
DC Current Input	4 to 20mA, 0 to 20mA

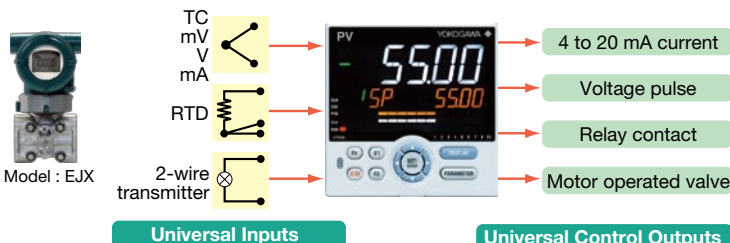

Position proportional control for Control motor

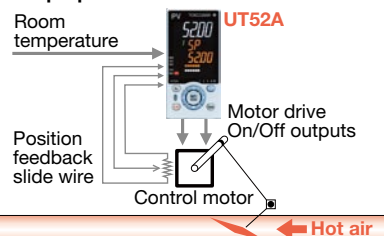

Digital Indicating Controller UT35A / UT32A (Standard model)



Main Features

- 4 target setpoints (PID numbers) available as standard
- 3 alarm independent common terminals available as standard
- Ladder sequence programs can be built
- Simple operation
- Up to 8 DOs (combinations available)
- Multiple language operation manual (Japanese, English, German, French, Spanish, Chinese, and Korean) available. Please specify the desired language when ordering.

External Dimensions

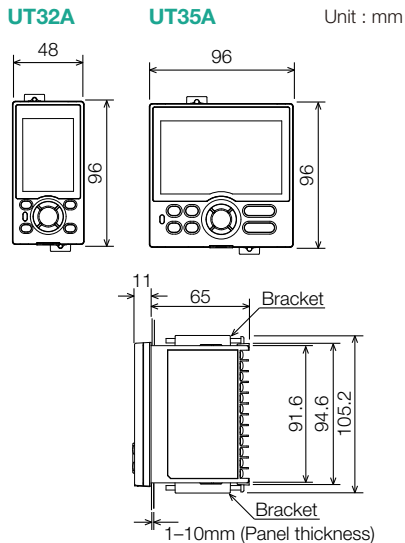

Model and Suffix Codes

Model	Suffix code	Optional suffix code	Description
UT35A			Digital Indicating Controller (provided with retransmission output or 15 V DC loop power supply, 2 DIs, and 3 DOs) (Power supply: 100-240 V AC)
Basic control	-0		Standard type
	-1		Position proportional type
	-2		Heating / cooling type
Functions	0		None
	1		2 additional DIs and 2 additional DOs
	2		5 additional DIs and 5 additional DOs
Open networks	0		None
	1		RS-485 communication (Max.38.4 kbps, 2-wire / 4-wire)
	2		Ethernet communication (with serial gateway function)
	3		CC-Link communication (with Modbus master function)
	4		PROFIBUS-DP communication (with Modbus master function)
	5		DeviceNet communication (with Modbus master function)
Display language (*1)	-1		English
	-2		German
	-3		French
	-4		Spanish
Case color	0		White (Light gray)
	1		Black (Light charcoal gray)
		-00	Always "-00"
Options		/LP	24 V DC loop power supply (* 2)
		/HA	Heater break alarm (* 3)
		/DC	Power supply 24 V AC / DC
		/CT	Coating (* 4)

- * 1: English, German, French, and Spanish can be displayed as the guide display.
 * 2: The /LP option can be specified in combination with function code "0" or "1" and open network code "0" or "1."
 * 3: The /HA option can be specified when basic control code is "-0" or "-2."
 * 4: When the /CT option is specified, the UT35A does not conform to the safety standards (UL and CSA) and CE marking.

Model	Suffix code	Optional suffix code	Description
UT32A			Digital Indicating Controller (provided with retransmission output or 15 V DC loop power supply, 2 DIs, and 3 DOs) (Power supply: 100-240 V AC)
Basic control	-0		Standard type
	-1		Position proportional type
	-2		Heating / cooling type
Functions	0		None
	1		RS-485 communication (Max.38.4 kbps, 2-wire / 4-wire) (* 2)
	2		2 additional DIs and 2 additional DOs
Open networks	0		None
Display language (*1)	-1		English
	-2		German
	-3		French
	-4		Spanish
Case color	0		White (Light gray)
	1		Black (Light charcoal gray)
		-00	Always "-00"
Options		/LP	24 V DC loop power supply (* 2)
		/HA	Heater break alarm (* 3)
		/DC	Power supply 24 V AC / DC
		/CT	Coating (* 4)

- * 1: English, German, French, and Spanish can be displayed as the guide display.
 * 2: The /LP option can be specified in combination with basic control code "-0" or "-1" and function code "0" or "1." Furthermore, when the function code is "1," the RS-485 communication is 2-wire system.
 * 3: The /HA option can be specified when basic control code is "-0" or "-2."
 * 4: When the /CT option is specified, the UT32A does not conform to the safety standards (UL and CSA) and CE marking.

Sold separately (Accessory)

Model Name	Model	Note
Terminal Cover	UTAP001	For UT55A/UT35A/UP55A/UP35A
	UTAP002	For UT52A/UT32A/UM33A
User's Manual (CD-ROM)	UTAP003	

Universal Output

User selectable for Relay, Voltage Pulse and Current outputs.

- Relay output: ON/OFF control, Time-proportional PID control
- Voltage Pulse output: Time-proportional PID control
- Current output: Continuous PID control

Heating/Cooling Control has two sets of universal outputs.

- Any combinations of Relay, Pulse and Current outputs are available.

Drive a Motorized Control Valve by using Position-Proportional PID.

- The position-proportional PID control function has two sets of relay outputs for direct / reverse rotation of motorized control valve.
- The slide wire input to feed back the valve position is also available.

Auto-Tuning (AT) Function

The following conditions can be set in order to increase the accuracy of calculating PID constants using AT .

- 1) Two types of algorithms to calculate PID constants are available for selection.
 Normal: Fast-rising PID constant
 Stable: Slow-rising PID constant
- 2) High and low output limits can be set individually for control output values during AT runtime.



Product line-up

Program Controller UP55A (Standard model)



Main Features

- Up to 30 program patterns
- 8 PV events, 16 time events, and 8 alarms can be monitored simultaneously
- Ladder sequence programs can be built
- Simple operation
- Up to 9 DIs and 18 DOs (combinations available)
- Multiple language operation manual (Japanese, English, German, French, Spanish, Chinese, and Korean) available. Please specify the desired language when ordering.

External Dimensions

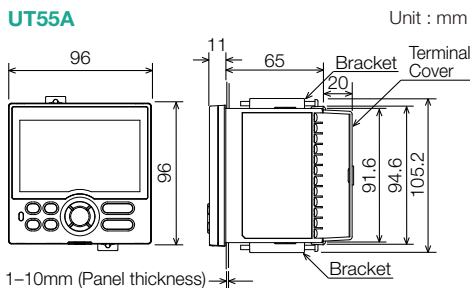

Model and Suffix Codes

Model	Suffix code	Optional suffix code	Description
UP55A			Program Controller (provided with retransmission output or 15 V DC loop power supply, 8 DIs, and 8 DOs) (Power supply: 100-240 V AC) 30 program patterns / 300 program segments (Max. 99 segments per pattern)
Basic control	-0		Standard type
	-1		Position proportional type
	-2		Heating/cooling type
Functions (*1)	0		None
	1		Remote (1 additional aux. analog) input, 1 additional DI
	2		RS-485 communication (Max.19.2 kbps, 2-wire/4-wire)
	3		10 additional DOs
	4		3 additional aux. analog inputs, 2 DIs and 5 DOs to be deleted
Open networks	0		None
	1		RS-485 communication (Max.38.4 kbps, 2-wire/4-wire)
	2		Ethernet communication (with serial gateway function)
	3		CC-Link communication (with Modbus master function)
	4		PROFIBUS-DP communication (with Modbus master function)
Display language (*2)	-1		English
	-2		German
	-3		French
	-4		Spanish
Case color	0		White (Light gray)
	1		Black (Light charcoal gray)
Fixed code		-00	Always "-00"
Optional suffix codes		/DR	Additional direct input (TC and 3-wire/4-wire RTD) and current input to Remote (1 additional aux. analog) input, 1 DI to be deleted (*3)
		/HA	Heater break alarm (*4)
		/DC	Power supply 24 V AC/DC
		/CT	Coating (*5)

* 1: When "3" is specified for the Function code, only "0" can be specified for the Open network code.

* 2: English, German, French, and Spanish can be displayed as the guide display.

* 3: When any of "1" or "4" is specified for the Function code, the /DR option can be specified.

* 4: When "-0" is specified for the Basic control code, the /HA option can be specified.

* 5: When the /CT option is specified, the UP55A does not conform to the safety standards (UL and CSA) and CE marking.

Program Controller UP35A (Standard model)



Main Features

- Up to 4 program patterns
- 2 PV events, 4 time events, and 2 alarms can be monitored simultaneously.
- Ladder sequence programs can be built
- Simple operation
- Up to 8 DIs and 8 DOs (combinations available)
- Multiple language operation manual (Japanese, English, German, French, Spanish, Chinese, and Korean) available. Please specify the desired language when ordering.

External Dimensions

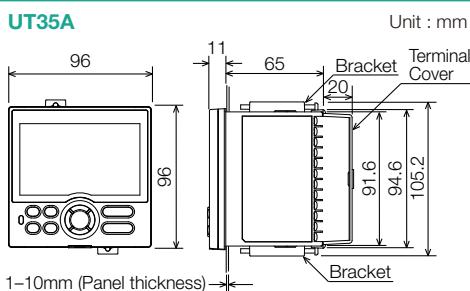

Model and Suffix Codes

Model	Suffix code	Optional suffix code	Description
UP35A			Program Controller (provided with retransmission output or 15 V DC loop power supply, 3 DIs, and 3 DOs) (Power supply: 100-240 V AC) 2 program patterns/20 program segments (Max. 20 segments per pattern)
Basic control	-0		Standard type
	-1		Position proportional type
	-2		Heating/cooling type
Functions	0		None
	1		5 additional DIs, 5 additional DOs
Open networks	0		None
	1		RS-485 communication (Max.38.4 kbps, 2-wire/4-wire)
	2		Ethernet communication (with serial gateway function)
	3		CC-Link communication (with Modbus master function)
	4		PROFIBUS-DP communication (with Modbus master function)
Display language (*1)	-1		English
	-2		German
	-3		French
	-4		Spanish
Case color	0		White (Light gray)
	1		Black (Light charcoal gray)
Fixed code		-00	Always "-00"
Optional suffix codes		/AP	2 additional patterns/20 additional segments
		/HA	Heater break alarm (*2)
		/DC	Power supply 24 V AC/DC
		/CT	Coating (*3)

* 1: English, German, French, and Spanish can be displayed as the guide display.

* 2: The /HA option can be specified when the Basic control code is "-0" or "-2."

* 3: When the /CT option is specified, the UP35A does not conform to the safety standards (UL and CSA) and CE marking.

Digital Indicator with Alarms UM33A (Standard model)



Main Features

- Up to 9 alarm outputs (including one Fail)
- Input correction function (PV bias, polygonal line approximation, polygonal line bias)
- 24 VDC sensor power supply available
- Simple operation
- Multiple language operation manual (Japanese, English, German, French, Spanish, Chinese, and Korean) available. Please specify the desired language when ordering.

External Dimensions

UM33A

Unit : mm

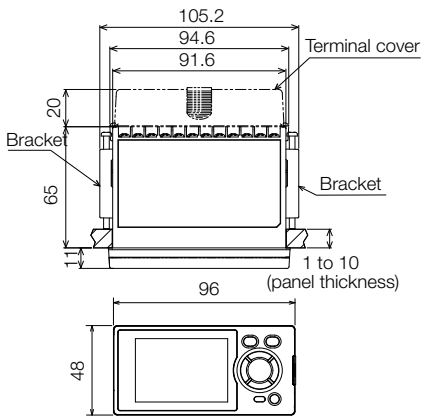

Model and Suffix Codes

Model	Suffix code	Optional suffix code	Description
UM33A			Digital Indicator with Alarms (provided with retransmission output or 15 V DC loop power supply, 2 DIs, and 3 DOs) (Power supply: 100-240 V AC)
Basic control	-0		Standard type
Functions	0		None
	1		1 additional DO (c-contact relay), RS-485 communication (Max. 38.4 kbps, 2-wire/4-wire)
	2		1 additional DO (c-contact relay)
	3		6 additional DOs (c-contact relay; 1 point and open collector; 5 points)
Open networks	0		None
Display language (*1)	-1		English
	-2		German
	-3		French
	-4		Spanish
Case color	0		White (Light gray)
	1		Black (Light charcoal gray)
Optional suffix codes	/LP		24 V DC loop power supply (*2)
	/DC		Power supply 24 V AC/DC
	/CT		Coating (*3)

* 1: English, German, French, and Spanish can be displayed as the guide display.

* 2: The /LP option can be specified only when the code for Function is "0", "1" or "2". Additionally, the RS-485 communication for "1" of the Function code is 2-wire system.

* 3: When the /CT option is specified, the UM33A does not conform to the safety standards (UL and CSA) and CE marking.

Other Convenient Functions Available

Parameter Setting

LL50A Parameter Setting Software (sold separately) allows for easily setting parameters.

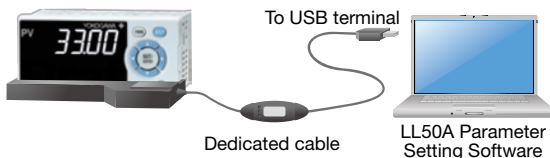

Quick Setting Function

Minimum parameters necessary for operation can be set.

Security Function

The password function can prevent inadvertent changes to the parameter settings. If a password is set, the password is required when moving to the Setup Parameter Setting Display. When the password is verified, can be changed to the Setup Parameter Setting Display.

Message Function

Using the message function and turning the contact input on/off, the message registered beforehand can be displayed on PV display by interrupt.

The message is registered using LL50A Parameter Setting Software. The messages are limited to 20 alphanumeric characters. A maximum of four messages can be registered.

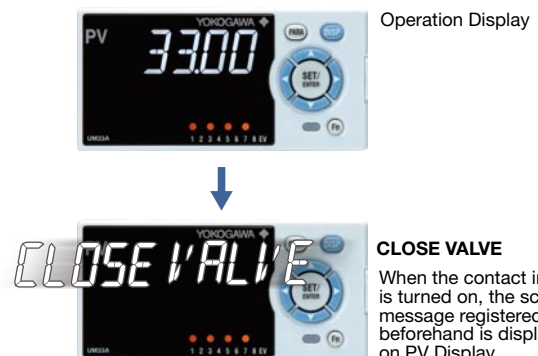

Operation Display

CLOSE VALVE
When the contact input is turned on, the scrolling message registered beforehand is displayed on PV Display.



Customize

The detailed code model allows you to customize specifications best suited to you.

- Detailed model code** – Control output individual selection
- Option selection
- Standard specifications** – One Universal input
- Three digital inputs/outputs (Alarms) * Note 1



Note 1: UT35A, UT32A: 2 points

Additional Functions

■ Triac output can be selected in Control Output: -T / - T

ITEM		Specification
Contact type		zero-cross
Contact capacity	Load voltage	75 to 250 V
	Allowable load current	0.8 A (at an ambient temperature of 25°C) 0.3 A (at an ambient temperature of 50°C)
Application		Time proportional control output
Time resolution of control output		1/commercial frequency (sec) or 0.1% of the output value, whichever greater

■ 2 DIs and 2 DOs combination specs can be selected: /W

The electrical specifications are the same as DI/DO incorporated in the standard model, except for the terminal arrangement.

Example : E1 terminal area option /W1

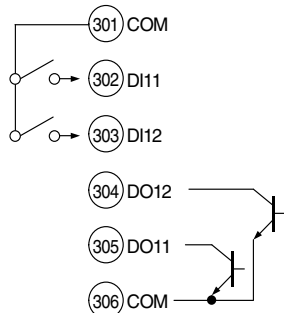

Terminal Positions when Additional Functions are Added

The positions of extended terminal areas E1 to E4 are shown below.

Please note that although the additional Functions are the same, the mount positions are different.

Example: When 5 DIs are added in the UT55A, the positions of the terminals to be mounted are different between /X1 (E1 area) and /X2 (E2 area) as shown below.

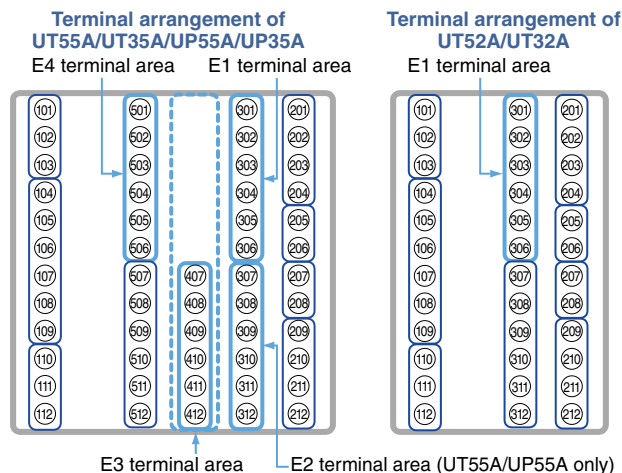

Detailed code model



Model and Suffix code

Language Case color Output1 Output2 General option Extension option1 Extension option2 Extension option3 Extension option4

UT55A-NNN-

Model	Suffix code	Optional suffix code	Description
UT55A			Digital Indicating Controller (provided with 3 DIs and 3 DOs) (Power supply 100-240 V AC)
Fix	-N N N		Always "-NNN"
Display language	-1		English
	-2		German
	-3		French
	-4		Spanish
Case color	0		White (Light gray)
	1		Black (Light charcoal gray)
Control output 1 (Heating-side, Position proportional) (* 1)	-A		Analog output (current/pulse)
	-R		Relay output (form C)
	-U		Universal output (current/pulse/relay)
	-T		Triac output
	-P		Position proportional output
Control output 2 (Cooling-side) (* 1)	A		Analog output (current/pulse)
	R		Relay output (form C)
	U		Universal output (current/pulse/relay)
	N		None
General option	/DC		Power supply 24 V AC/DC
	/CT		Coating (* 3)
	/HA		Heater break alarm
	/RT		Retransmission output or 15 V DC loop power supply
E1 terminal area option (* 2)	/R1		Remote (1 additional aux. analog input and 1 additional DI)
	/U1		1 additional universal input (TC/RTD/DCV/mA)
	/X1		5 additional DIs
	/Y1		5 additional DOs
E2 terminal area option (* 2)	/W1		2 additional DIs and 2 additional DOs
	/A2		1 additional aux. analog input and 1 additional DI
	/X2		5 additional DIs
	/Y2		5 additional DOs
E3 terminal area option (* 2)	/W2		2 additional DIs and 2 additional DOs
	/CH3		RS-485 communication (Max.38.4 kbps, 2-wire/4-wire)
	/CC3		CC-Link communication (with Modbus master function)
	/PD3		PROFIBUS-DP communication (with Modbus master function)
	/DN3		DeviceNet communication (with Modbus master function)
	/ET3		Ethernet communication (with serial gateway function)
E4 terminal area option (* 2,4)	/X3		5 additional DIs
	/Y3		5 additional DOs
	/W3		2 additional DIs and 2 additional DOs
	/A4		1 additional aux. analog input and 1 additional DI
	/C4		RS-485 communication (Max.19.2 kbps, 2-wire/4-wire)
	/L4		24 V DC loop power supply
	/AC4		1 additional aux. analog input, 1 additional DI, and RS-485 communication (Max.19.2 kbps, 2-wire)
	/LC4		24 V DC loop power supply and RS-485 communication (Max.19.2 kbps, 2-wire)
	/X4		5 additional DIs
	/Y4		5 additional DOs
	/W4		2 additional DIs and 2 additional DOs

* 1) For heating /cooling output, specify both Output1 and Output2. Not available when Output2 is "N". For Position proportional output, specify "P" for Output1 and "N" for Output2. The /HA option can be specified when the code of Output1 and Output2 is "-AN", "-RN", "-UN" or "-TN".
 * 2) One option can be selected from each of E1 to E4 terminal area options.
 * 3) When the /CT option is specified, the UT55A does not conform to the safety standards (UL and CSA) and CE marking.
 * 4) The "L1" and "LC1" of E4 terminal area option can be specified when E3 terminal area option is "Not select", "/CH3", "/X3", "/Y3", or "/W3".

Display language
Select one type.

Case color
Select one type.
Output1
Select one type.

Output2
When you perform heating/cooling control, select one type. If you select -P in Output 1, specify N.

General option
Select any options you need.

Extension option1
Select one type.

Extension option2
Select one type.

Extension option3
Select one type.

Extension option4
Select one type.

Detailed code model



Model and Suffix code

Language Case color Output1 Output2 General option Extension option1

UT52A-NNN-

Model	Suffix code	Optional suffix code	Description
UT52A			Digital Indicating Controller (provided with 3 DIs and 3 DOs) (Power supply 100-240 V AC)
Fix	-N N N		Always "-NNN"
Display language	-1		English
	-2		German
	-3		French
	-4		Spanish
Case color	0		White (Light gray)
	1		Black (Light charcoal gray)
Control output 1 (Heating-side, Position proportional) (* 1 and 4)	-A		Analog output (current/pulse)
	-R		Relay output (form C)
	-U		Universal output (current/pulse/relay)
	-T		Triac output
	-P		Position proportional output
Control output 2 (Cooling-side) (* 1 and 4)	A		Analog output (current/pulse)
	R		Relay output (form A)
	U		Universal output (current/pulse/relay)
	N		None
General option	/DC		Power supply 24 V AC/DC
	/CT		Coating (* 3)
	/HA		Heater break alarm
	/RT		Retransmission output or 15 V DC loop power supply
E1 terminal area option (* 2, 5)	/R1		Remote (1 additional aux. analog input and 1 additional DI)
	/U1		1 additional universal input (TC/RTD/DCV/mA)
	/L1		24 V DC loop power supply
	/CH1		RS-485 communication (Max.38.4kbps, 2-wire/4-wire)
	/RCH1		Remote (1 additional aux. analog input, 1 additional DI, and RS-485 communication (Max.38.4kbps, 2-wire)
	/LC1		24 V DC loop power supply and RS-485 communication (Max.38.4kbps, 2-wire)
	/X1		5 additional DIs
	/Y1		5 additional DOs
	/W1		2 additional DIs and 2 additional DOs

* 1) For heating /cooling output, specify both Output1 and Output2. Not available when Output2 is "N". For Position proportional output, specify "P" for Output1 and "N" for Output2. The /HA option can be specified when the code of Output1 and Output2 is "-AN", "-RN", "-UN" or "-TN".
 * 2) One option can be selected from E1 terminal area option.
 * 3) When the /CT option is specified, the UT52A does not conform to the safety standards (UL and CSA) and CE marking.
 * 4) When Output1 is "R", "U", contact point C is changed to contact point A when Output2 is "R" or "U". When Output1 is "T", only "A" or "N" can be specified for Output2.
 * 5) The "L1" and "LC1" can be specified when Output2 is "N".

Display language
Select one type.

Case color
Select one type.
Output1
Select one type.

Output2
When you perform heating/cooling control, select one type. If you select -P in Output 1, specify N.

General option
Select any options you need.

Extension option1
Select one type.



Customize

Detailed code model

Model and Suffix code

UT35A-NNN------------



Model	Suffix code	Optional suffix code	Description
UT35A			Digital Indicating Controller (provided with 2 DIs and 3 DOs) (Power supply 100-240 V AC)
Fix	-N N N		Always "-NNN"
Display language	-1		English
	-2		German
	-3		French
	-4		Spanish
Case color	0		White (Light gray)
	1		Black (Light charcoal gray)
Control output 1 (Heating-side, Position proportional) (* 1, 2 and 4)	-A		Analog output (current/pulse)
	-R		Relay output (form C)
	-U		Universal output (current/pulse/relay)
	-T		Triac output
	-P		Position proportional output
Control output 2 (Cooling-side) (* 1, 2, 4 and 5)	A		Analog output (current/pulse)
	R		Relay output (form A)
	U		Universal output (current/pulse/relay)
	N		None
General option	/DC		Power supply 24 V AC/DC
	/CT		Coating (* 3)
	/HA		Heater break alarm (* 4)
	/RT		Retransmission output or 15 V DC loop power supply (* 5)
	/X1		5 additional DIs
E1 terminal area option (* 6)	/Y1		5 additional DOs
	/W1		2 additional DIs and 2 additional DOs
E3 terminal area option (* 6 and 7)	/CH3		RS-485 communication (Max.38.4 kbps, 2-wire/4-wire)
	/CC3		CC-Link communication (with Modbus master function)
	/PD3		PROFIBUS-DP communication (with Modbus master function)
	/DN3		DeviceNet communication (with Modbus master function)
	/ET3		Ethernet communication (with serial gateway function)
E4 terminal area option (* 6 and 7)	/L4		24 V DC loop power supply
	/X4		5 additional DIs
	/Y4		5 additional DOs
	/W4		2 additional DIs and 2 additional DOs

Display language
Select one type.

Case color
Select one type.

Output1
Select one type.

Output2
When you perform heating/cooling control, select one type. If you select -P in Output 1, specify N.

General option
Select any options you need.

Extension option1
Select one type.

Extension option3
Select one type.

Extension option4
Select one type.

- * 1) For heating /cooling output, both Output 1 and Output 2 should be specified. Not available when Output 2 is "N".
For position proportional output, specify "-P" for Output 1 and "N" for Output 2.
- * 2) When the code for Output 1 is "-R" or "-U" and Output 2 is "R" or "U", Output 1 is changed from the contact point c to the contact point a.
- * 3) When the code for Output 1 is specified to "-T", only "A" or "N" is available for Output 2.
- * 4) The /HA option can be specified in the combination of Output 1 and Output 2 codes except for "-PN".
- * 5) The /RT option can be specified only when the code for Output 2 is "-R" or "N".
- * 6) Only one option is available for each terminal area of E1, E3 and E4.
- * 7) The /L4 option for E4 terminal area can be specified only when the E3 terminal area option is not specified or specified /CH3.

Detailed code model

Model and Suffix code

UT32A-NNN--------



Model	Suffix code	Optional suffix code	Description
UT32A			Digital Indicating Controller (provided with 2 DIs and 3 DOs) (Power supply 100-240 V AC)
Fix	-N N N		Always "-NNN"
Display language	-1		English
	-2		German
	-3		French
	-4		Spanish
Case color	0		White (Light gray)
	1		Black (Light charcoal gray)
Control output 1 (Heating-side, Position proportional) (* 1, 2 and 4)	-A		Analog output (current/pulse)
	-R		Relay output (form C)
	-U		Universal output (current/pulse/relay)
	-T		Triac output
	-P		Position proportional output
Control output 2 (Cooling-side) (* 1, 2, 4 and 5)	A		Analog output (current/pulse)
	R		Relay output (form A)
	U		Universal output (current/pulse/relay)
	N		None
General option	/DC		Power supply 24 V AC/DC
	/CT		Coating (* 3)
	/HA		Heater break alarm (* 4)
	/RT		Retransmission output or 15 V DC loop power supply (* 5)
	/L1		24 V DC loop power supply
E1 terminal area option (* 6)	/CH1		RS-485 communication (Max.38.4 kbps, 2-wire/4-wire)
	/LCH1		24 V DC loop power supply and RS-485 communication (Max.38.4 kbps, 2-wire)
	/X1		5 additional DIs
	/Y1		5 additional DOs
		/W1	2 additional DIs and 2 additional DOs

Display language
Select one type.

Case color
Select one type.

Output1
Select one type.

Output2
When you perform heating/cooling control, select one type. If you select -P in Output 1, specify N.

General option
Select any options you need.

Extension option1
Select one type.

- * 1) For heating /cooling output, both Output 1 and Output 2 should be specified. Not available when Output 2 is "N".
For position proportional output, specify "-P" for Output 1 and "N" for Output 2.
- * 2) When the code for Output 1 is "-R" or "-U" and Output 2 is "R" or "U", Output 1 is changed from the contact point c to the contact point a.
- * 3) When the code for Output 1 is specified to "-T", only "A" or "N" is available for Output 2.
- * 4) The /HA option can be specified in the combination of Output 1 and Output 2 codes except for "-PN".
- * 5) The /RT option can be specified only when the code for Output 2 is "R" or "N".
- * 6) Only one option is available for E1 terminal area.
The /L1 or /LCH1 option can be specified only when the code for Output 2 is "N".

Detailed code model



Model and Suffix code

UP55A-NNN- [Language] [Case color] [Output1] [Output2] [General option] [Extension option1] [Extension option2] [Extension option3] [Extension option4]

Model	Suffix code	Optional suffix code	Description
UP55A			Program Controller (provided with 3 DIs, and 3 DOs) (Power supply: 100-240 V AC) 30 program patterns/300 program segments (Max. 99 segments per pattern)
Fix	-N N N		Always "-NNN"
Display language (*1)	-1		English
	-2		German
	-3		French
	-4		Spanish
Case color	0		White (Light gray)
	1		Black (Light charcoal gray)
Control Output 1 (*2 and 3)	-A		Analog output (current/voltage pulse)
	-R		Relay output (c-contact)
	-U		Universal output (current/voltage pulse/relay)
	-T		Triac output
	-P		Position proportional output
Control Output 2 (*2 and 3)	A		Analog output (current/voltage pulse)
	R		Relay output (c-contact)
	U		Universal output (current/voltage pulse/relay)
	T		Triac output
General option	N		None
	/DC		Power supply 24 V AC/DC
	/CT		Coating
	/HA		Heater break alarm
	/RT		Retransmission output or 15 V DC power supply
E1 terminal area option (* 4)	/R1		Remote (1 additional aux. analog) input and 1 additional DI
	/U1		1 additional universal input (TC/RTD/DCV/mA)
	/X1		5 additional DIs
	/Y1		5 additional DOs
E2 terminal area option (* 4)	/W1		2 additional DIs and 2 additional DOs
	/A2		1 additional aux. analog input and 1 additional DI
	/X2		5 additional DIs
	/Y2		5 additional DOs
E3 terminal area option (* 4 and 5)	/W2		2 additional DIs and 2 additional DOs
	/CH3		RS-485 communication (Max. 38.4 kbps, 2-wire/4-wire)
	/CC3		CC-Link communication (with Modbus master function)
	/PD3		PROFIBUS-DP communication (with Modbus master function)
	/DN3		DeviceNet communication (with Modbus master function)
	/ET3		Ethernet communication (with serial gateway function)
E4 terminal area option (* 4 and 5)	/X3		5 additional DIs
	/Y3		5 additional DOs
	/W3		2 additional DIs and 2 additional DOs
	/A4		1 additional aux. analog input and 1 additional DI
	/C4		RS-485 communication (Max. 19.2 kbps, 2-wire/4-wire)
	/L4		24 V DC loop power supply
	/AC4		1 additional aux. analog input, 1 additional DI, and RS-485 communication (Max.19.2 kbps, 2-wire)
	/LC4		24 V DC loop power supply and RS-485 communication (Max.19.2 kbps, 2-wire)
	/X4		5 additional DIs
	/Y4		5 additional DOs
	/W4		2 additional DIs and 2 additional DOs

Display language
Select one type.

Case color
Select one type.

Output1
Select one type.

Output2
When you perform heating/cooling control, select one type. If you select -P in Output 1, specify N.

General option
Select any options you need.

Extension option1
Select one type.

Extension option2
Select one type.

Extension option3
Select one type.

Extension option4
Select one type.

* 1) English, German, French, and Spanish can be displayed as the guide display.
 * 2) For heating/cooling output, both Output 1 and Output 2 should be specified. Not available when Output 2 is "N". For position proportional output, specify "-P" for Output 1 and "N" for Output 2.
 * 3) The /HA option can be specified only when the code for Output 1 and 2 is "-AN", "-RN", "-UN" or "-TN".
 * 4) Only one option is available for each terminal area of E1 to E4.
 * 5) The /L4 and /LC4 options for E4 terminal area can be specified only when the E3 terminal area option is not specified or specified any of /CH3, /X3, /Y3 or /W3.
 * 6) When the /CT option is specified, the UP55A does not conform to the safety standards (UL and CSA) and CE marking.

Detailed code model



Model and Suffix code

UP35A-NNN- [Language] [Case color] [Output1] [Output2] [General option] [Extension option1] [Extension option3] [Extension option4]

Model	Suffix code	Optional suffix code	Description
UP35A			Program Controller (provided with 3 DIs, and 3 DOs) (Power supply: 100-240 V AC) 2 program patterns/20 program segments (Max. 20 segments per pattern)
Fix	-N N N		Always "-NNN"
Display language (*1)	-1		English
	-2		German
	-3		French
	-4		Spanish
Case color	0		White (Light gray)
	1		Black (Light charcoal gray)
Control Output 1 (*2, 3 and 5)	-A		Analog output (current/voltage pulse)
	-R		Relay output (c-contact)
	-U		Universal output (current/voltage pulse/relay)
	-T		Triac output
	-P		Position proportional output
Control Output 2 (*2, 3, 4 and 5)	A		Analog output (current/voltage pulse)
	R		Relay output (a-contact)
	U		Universal output (current/voltage pulse/relay)
	N		None
General option	/AP		2 additional patterns/20 additional segments
	/DC		Power supply 24 V AC/DC
	/CT		Coating
	/HA		Heater break alarm
	/RT		Retransmission output or 15 V DC power supply
E1 terminal area (*6)	/X1		5 additional DIs
	/Y1		5 additional DOs
E3 terminal area (*6 and 7)	/W1		2 additional DIs and 2 additional DOs
	/CH3		RS-485 communication (Max. 38.4 kbps, 2-wire/4-wire)
	/CC3		CC-Link communication (with Modbus master function)
	/PD3		PROFIBUS-DP communication (with Modbus master function)
E4 terminal area (*6 and 7)	/DN3		DeviceNet communication (with Modbus master function)
	/ET3		Ethernet communication (with serial gateway function)
	/L4		24 V DC loop power supply
	/X4		5 additional DIs
	/Y4		5 additional DOs
	/W4		2 additional DIs and 2 additional DOs

Display language
Select one type.

Case color
Select one type.

Output1
Select one type.

Output2
When you perform heating/cooling control, select one type. If you select -P in Output 1, specify N.

General option
Select any options you need.

Extension option1
Select one type.

Extension option3
Select one type.

Extension option4
Select one type.

* 1) English, German, French, and Spanish can be displayed as the guide display.
 * 2) For heating/cooling output, both Output 1 and Output 2 should be specified. Not available when Output 2 is "N". For position proportional output, specify "-P" for Output 1 and "N" for Output 2.
 * 3) When the code for Output 1 is "-R" or "-U" and Output 2 is "R" or "U", Output 1 is changed from the contact point c to the contact point a. When the code for Output 1 is specified to "-T", only "A" or "N" is available for Output 2.
 * 4) The /RT option can be specified only when the code for Output 2 is "R" or "N".
 * 5) The /HA option can be specified in the combination of Output 1 and Output 2 codes except for "-PN".
 * 6) Only one option is available for each terminal area of E1, E3 and E4.
 * 7) The /L4 option for E4 terminal area can be specified only when the E3 terminal area option is not specified or specified /CH3.
 * 8) When the /CT option is specified, the UP35A does not conform to the safety standards (UL and CSA) and CE marking.



Configuration Tool

LL50A Parameters Setting Software

Parameter Setting/Program Pattern Creating Function

Parameters that determine controller functions can easily be set: controller model type, controller mode (single-loop control, cascade control, loop control with PV switching, etc.), universal input/output functions, setup parameters and others. It also allows you to create program patterns.

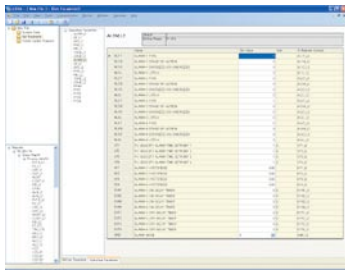

Parameters setting display

Tuning Function

Used to tune a controller's PID parameters. Displays measured input value, target setpoint, and control output value as a trend graph on a personal computer screen, allowing PID parameter modification, AUTO/MAN switching, control output modification in manual operation, etc.

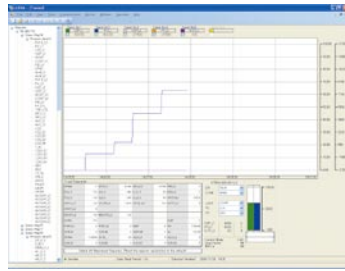

Tuning display

Ladder Building Functions

Ladder sequence programs can be created and ladder programs can be monitored.

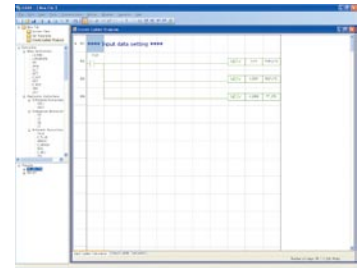

Ladder programs building display

Network Profile Creating Function

Can be used to create an electronic device data sheet for Open Network.

Via Bus Powered USB Cable

Can be set parameters while no power supply to controller.



Via Ethernet Communication Connector

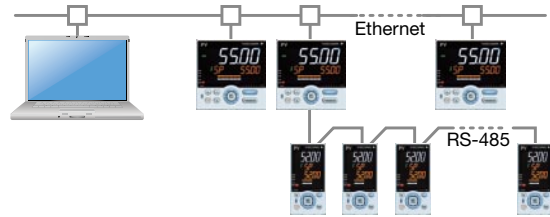

Via Dedicated Adapter

Can be used while attached to the control panel.



Via RS-485 Communication Terminals

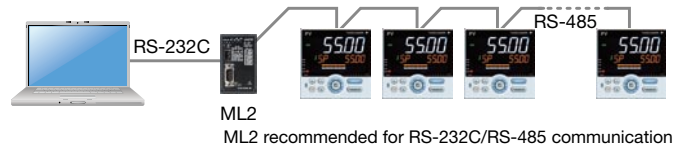

- Applicable Controllers : UT55A, UT52A
UT35A, UT32A
UP55A, UP35A
UM33A
- Applicable OS : Windows XP / Vista
- Communication method : USB 1.1

Model and Suffix Code

Model	Suffix code	Description
LL50A	-00	Parameters Setting Software

UTAdvanced is a registered trademark of Yokogawa Electric Corporation. Microsoft, MS, and Windows are registered trademarks or trademarks of Microsoft Corporation in the United States and other countries. Other company names and product names appearing in this document are registered trademarks or trademarks of their respective holders.

A parameter conversion tool that enables GREEN series parameter data to be used with the LL50A is available and downloadable from the website below.
<https://y-link.yokogawa.com>

vigilantplant.[®]

SEE
CLEARLY

KNOW
IN ADVANCE

ACT
WITH AGILITY

The clear path to operational excellence

VigilantPlant is Yokogawa's automation concept for safe, reliable, and profitable plant operations. VigilantPlant aims to enable an ongoing state of Operational Excellence where plant personnel are watchful and attentive, well-informed, and ready to take actions that optimize plant and business performance.

YOKOGAWA ELECTRIC CORPORATION

Network Solutions Business Div./Phone: (81)-422-52-7179, Fax: (81)-422-52-6619
E-mail: ns@cs.jp.yokogawa.com

YOKOGAWA CORPORATION OF AMERICA
YOKOGAWA EUROPE B.V.
YOKOGAWA ENGINEERING ASIA PTE. LTD.

Phone: 800-258-2552, Fax: (1)-770-254-0928
Phone: (31)-88-4641000, Fax: (31)-88-4641111
Phone: (65)-62419933, Fax: (65)-62412606

NetSOL Online

Sign up for our free e-mail newsletter
www.yokogawa.com/ns/

Vig-RS-4E

Printed in Japan, 007 (KP) [Ed : 04/b]

Subject to change without notice.
All Rights Reserved, Copyright © 2009, Yokogawa Electric Corporation.

YOKOGAWA