

Industrial Recorders SR10000



SR10000

Industrial Recorders

The SR10000 is a small compact industrial recorder with a recording width of 100 mm. The model family consists of 1, 2, 3, 4 pen and a 6 dot model. The SR10000 offers outstanding clear display of field data and reliability of recording data.

Bulletin BU04P03B01-01E

www.yokogawa.com

Includes a Full Set of Basic Recorder Functions

SR10000 is a new compact recorder, including basic recorder functions such as measurement, recording, and display offered by leading-edge technology. Operating efficiency is increased through easy-to-read data and ease of operation.



Introducing the 4 Pen Model

Provides 1, 2, 3, 4 pen model and 6 dot model.

**Large
(10 x18 mm)
LED display**

**Universal
inputs**

**Robust,
splash-proof
design (IP54)**

**Network
compatible**

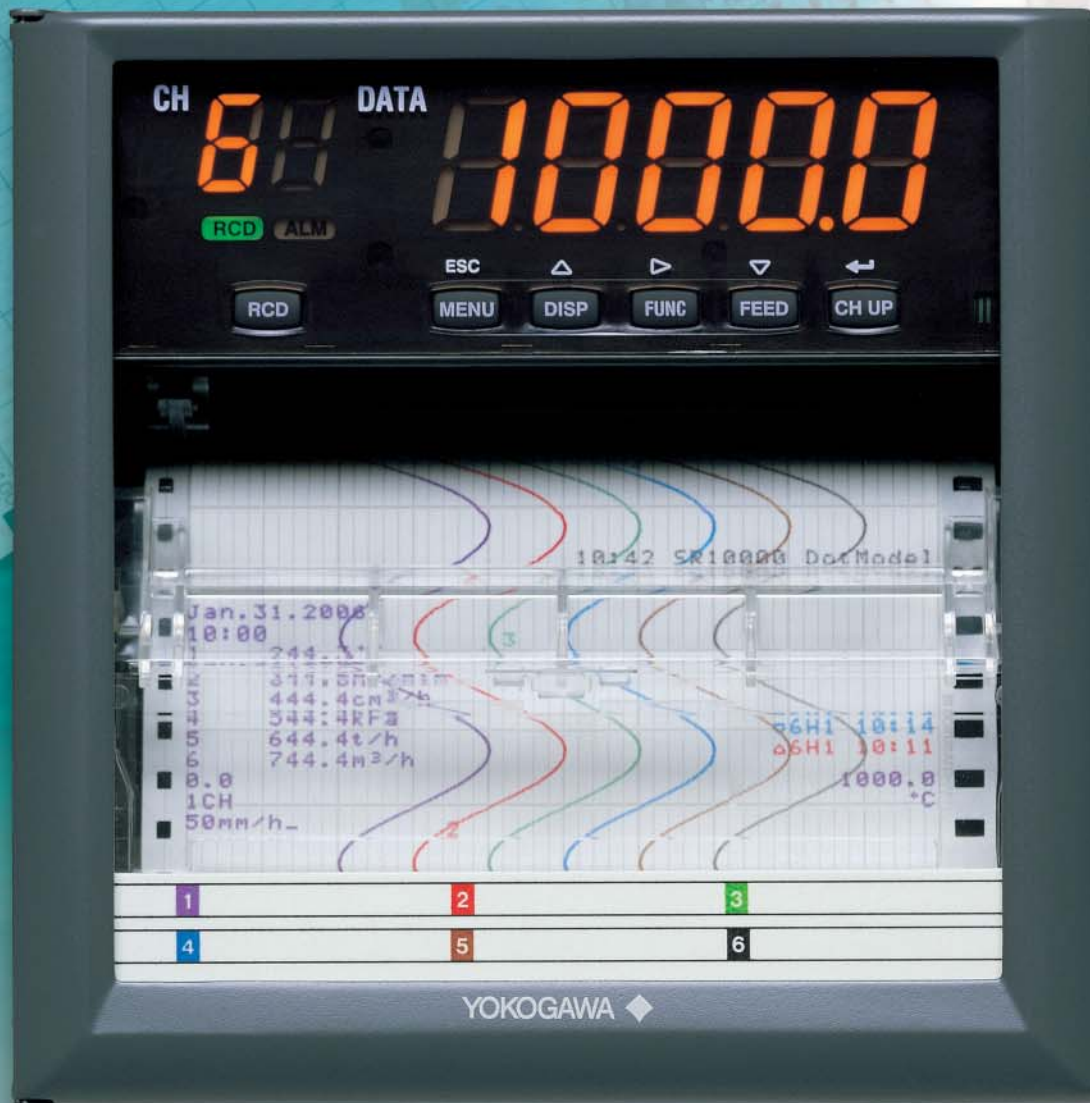

Actual Size: 144x144mm

Large, Vivid LED Display

SR10000 displays data for easy viewing on a large display (10x18mm/segment), allowing the on-site operators to immediately check the operational status of equipment.

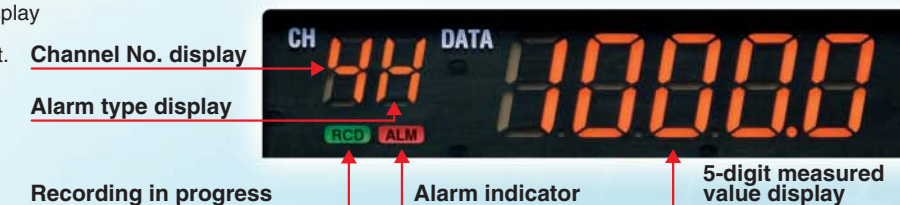

Easy, Interactive Configuration

- Parameters are easily configured using the SR10000's display keys. For example, when setting the input range, the channel number, range type, and span are configured in order using the Menu key, arrow keys (↑→↓), and the (←) key.
- Parameter configuration using PC software. Parameter configuration, saving of settings, and downloading of settings can be performed on a PC.

The high reliability demanded for industrial recorders

The SR10000's popularity is a testimony to its high reliability, made possible with the latest technology.

- Fully contact-less technology
- Actuators reduced in size through high precision manufacturing
- High degree of integration using custom ICs
- Dust and splash proof front door (conforms to IP 54)



Convenient Components Offer Ease of Operation

- Provides an easy-to-use disposable felt-pen cartridge (for pen model) and ribbon cassette (for dot model).
- The chart cassette is equipped with a chart ejection function. You can write memos on the chart and check the historical trend during recording.



Easy to Read and Easy to Operate Print and Record Functions

The SR10000 has variety functions such as pen offset compensation which compensates for the pen offset (phase difference) along the time axis, printing functions (message, alarm, and periodic printout), zone recording, and partial expanded recording.

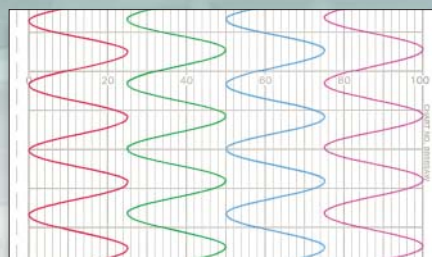

Zone recording

Lets you set a distinct analog recording zone for each channel.

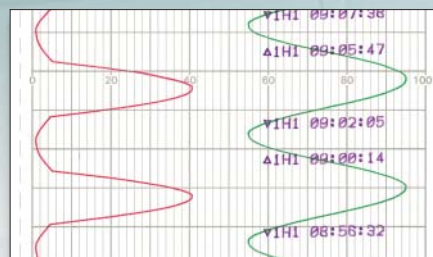

Partial expanded recording

Lets you expand the section of recording range to record detail.

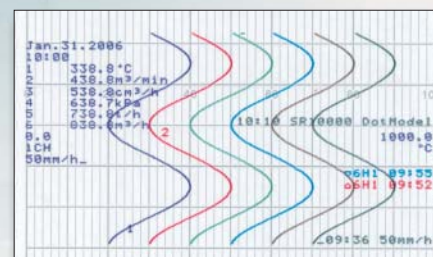

Message printout

Lets you write the pre-registered messages.

Specifications

See the general specifications (GS04P03B01-01E) for more details.

Input section

Measurement points: 1-4 pens, 6 dots
Input type:
Universal input
DCV : 20 mV, 60 mV, 200 mV, 2 V, 6 V, 20 V, 50 V
TC : R, S, B, K, E, J, T, N, W, L, U, W3re/W25re
RTD: Pt100
DI : Voltage input (TTL), contact input
DCA: Direct current input (with external shunt register)
Measurement intervals:
Pen models 125 ms
Dot models; 1 s/6 points, 2.5 s/6 points
Computation: Differential computation, linear scaling, square root, bias addition

Recording section

Effective recording width: 100 mm
Recording period:
Pen model : Continuous for each channel
Dot model : 6 ch/10sec
(the shortest recording period)

Display section

Display method: LED array display (2 small and 5 large digits, each comprising 7 LED segments)
Display types : Channel No., alarm type, measured value, date/time etc.
Status display: Recording in progress, shared alarm display

Alarm function

Number of levels: 4 levels per channel
Type of alarm : Higher/lower limit, differential higher/lower limit

Optional functions

Alarm output relay (2, 4, 6 points), remote control, expansion inputs, AC/DC24V power supply, calibration correction communication interface (RS-422A/485 or Ethernet), and others.

Construction

Front panel : Water- and dust-proof (based on IEC529-IP54)
Dimensions: 144 (W) x 144 (H) x 233 (D) mm
Weight : 2.1 kg-2.5 kg

Power supply

Rated voltage : 100 to 240 VAC, automatically selected
Rated frequency : 50/60 Hz
Power consumption: 18 VA (In balance), maximum 40 VA

Industrial Recorders SR10000

Model Codes

Model code	Suffix code	Option code	Description
SR10001			1 pen recorder
SR10002			2 pen recorder
SR10003			3 pen recorder
SR10004			4 pen recorder
SR10006			6 dot recorder
	-2		English deg F, DST (summer/winter time)
Option		/A1	Alarm output relay (2 contact)*1
		/A2	Alarm output relay (4 contact)*1
		/A3	Alarm output relay (6 contact)*1
		/CC1	Calibration correction
		/C3	RS-422/485 Communication interface*2
		/C7	Ethernet communication interface*2
		/D6	Green display
		/N1	Cu10, Cu25 input
		/N3	Expansion inputs
	/P1	24V DC/AC power supply	
	/R1	Remote control	

*1: /A1, /A2, /A3 cannot be specified together.
*2: /C3, /C7 cannot be specified together.

Application Software

Model	Description	OS
RXA10-01	RXA10 configuration software	Windows 2000/XP
RXA10-02	RXA10 configuration software (with interface unit)	Windows 2000/XP

Note Support for RXA10 configuration software is phased in.

Standard Accessories

Name	1 pen	2 pen	3 pen	4 pen	6 dot	
Z-fold chart	1	1	1	1	1	
6 color ribbon cassette	-	-	-	-	1	
Disposable felt pen cartridge	Red	1	1	1	-	
	Green	-	1	1	-	
	Blue	-	-	1	1	-
	Violet	-	-	-	1	-
Plotter pen	Purple	1	1	1	1	
Mounting bracket	2	2	2	2	2	
User's Manual (CD-ROM)	1	1	1	1	1	
User's Manual (Operation Guide)	1	1	1	1	1	

Spare Parts/Optional Accessories

Name	Model code (part number)	Specification	
Z-fold chart	B9565AW	10 (Sales unit)	
6 color ribbon cassette	B9901AX	1 (Sales unit)	
Disposable felt pen cartridge	Red	B9902AM	1 (Sales unit, 3 pieces/unit)
	Green	B9902AN	1 (Sales unit, 3 pieces/unit)
	Blue	B9902AP	1 (Sales unit, 3 pieces/unit)
	Violet	B9902AQ	1 (Sales unit, 3 pieces/unit)
Plotter pen	B9902AR	1 (Sales unit, 3 pieces/unit)	
Mounting bracket	B9900BX	2 (Sales unit)	
	4159 20	250 Ω ±0.1%	
	4159 21	100 Ω ±0.1%	
Shunt resistor	4159 22	10 Ω ±0.1%	

Dimensions

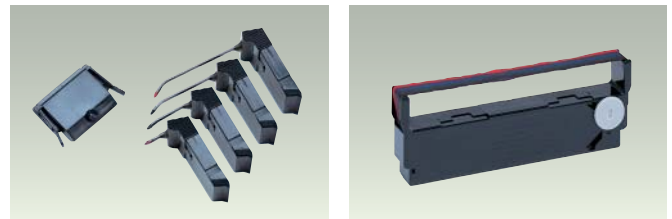
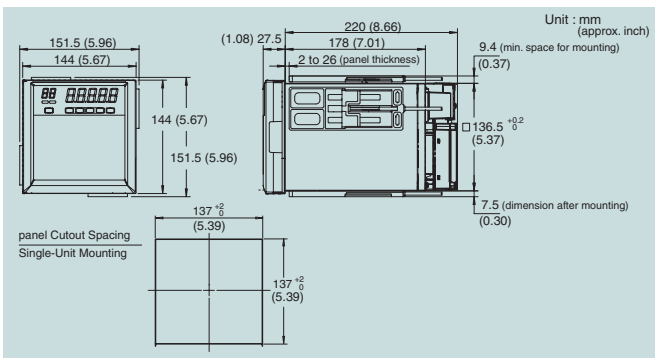

Pen Plotter pen

Ribbon cassette

Microsoft, MS, and Windows are registered trademarks or trademarks of Microsoft Corporation in the United States and other countries.
Ethernet is a registered trademark of Xerox Corporation.
Modbus is a registered trademark of AEG Schneider Automation Inc.
Other company names and product names appearing in this document are registered trademarks or trademarks of their respective holders.

NOTICE

- Before operating the product, read the instruction manual thoroughly for proper and safe operation.
- If this product is for use with a system requiring safeguards that directly involve personnel safety, please contact the Yokogawa sales offices.

A Yokogawa Commitment to Industry

vigilance

quality

innovation

foresight

What does Yokogawa **vigilance** mean to the future of your business? **Quality**. Through products that are built from the ground up and tested to the last hour, you're ensured continuous operation and more uptime. **Innovation**. Your business will benefit from new insights and capabilities, bringing true predictability to your process. **Foresight**. As the market changes, you'll have solutions that give you the continuity and flexibility to plan ahead and grow. Our partners know the difference. With Yokogawa, you can count on a lifetime of plant efficiency, from instrumentation to operation support. Let us be vigilant about your business.

YOKOGAWA ELECTRIC CORPORATION

Network Solutions Business Div./Phone: (81)-422-52-7179, Fax: (81)-422-52-6619

E-mail: ns@cs.jp.yokogawa.com

YOKOGAWA CORPORATION OF AMERICA

Phone: 800-888-6400, Fax: (1)-770-251-6427

YOKOGAWA EUROPE B.V.

Phone: (31)-33-4641806, Fax: (31)-33-4641807

YOKOGAWA ENGINEERING ASIA PTE. LTD.

Phone: (65)-62419933, Fax: (65)-62412606

NetSOL Online

Sign up for our free e-mail newsletter
www.yokogawa.com/ns/

Vig-RS-1E

Printed in Japan, 601(KP) [Ed : 01/b]

Subject to change without notice.

All Rights Reserved, Copyright © 2006, Yokogawa Electric Corporation.

YOKOGAWA