

# Analyzers

Water and Wastewater Measuring Systems

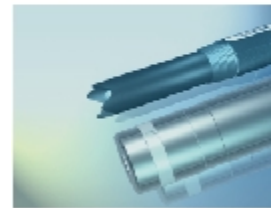

## WZ-RC300/310 Residual Chlorine Transmitter

Free Chlorine & Temperature Measurement.

2Channel Current Read-out.

Large Custom LCD & Backlit.

DIN144 Size Panel Mount Type

## **ESSENTIAL INSTRUCTIONS**

READ THIS PAGE BEFORE PROCEEDING!

PNI Technology designs, manufactures, and tests its products to meet many national and international standards. Because these instruments are sophisticated technical products, you must properly install, use, and maintain them to ensure they continue to operate within their normal specifications. The following instructions must be adhered to and integrated into your safety program when installing, using, and maintaining PNI Technology products.

Failure to follow the proper instructions may cause any one of the following situations to occur: Loss of life, personal injury, property damage, damage to this instrument, and warranty invalidation.

- Read all instructions prior to installing, operating, and servicing the product. If this Instruction Manual is not the correct manual, E-mail [pni@pnikorea.com](mailto:pni@pnikorea.com) and the requested manual will be provided. Save this Instruction Manual for future reference.
- If you do not understand any of the instructions, contact your PNI Technology representative for clarification.
- Follow all warnings, cautions, and instructions marked on and supplied with the product.
- Inform and educate your personnel in the proper installation, operation, and maintenance of the product.
- Install your equipment as specified in the Installation Instructions of the appropriate Instruction Manual and per applicable local and national codes. Connect all products to the proper electrical and pressure sources.
- To ensure proper performance, use qualified personnel to install, operate, update, program, and maintain the product.
- When replacement parts are required, ensure that qualified people use replacement parts specified by PNI Technology. Unauthorized parts and procedures can affect the product's performance and place the safe operation of your process at risk. Look alike substitutions may result in fire, electrical hazards, or improper operation.
- Ensure that all equipment doors are closed and protective covers are in place, except when maintenance is being performed by qualified persons, to prevent electrical shock and personal injury.

## WARNING! ELECTRICAL SHOCK HAZARD

- Making cable connections to and servicing this instrument require access to shock hazard level voltages which can cause death or serious injury, therefore, disconnect all hazardous voltage before accessing the electronics.
- Relay contacts made to separate power sources must be disconnected before servicing.
- Electrical installation must be in accordance with the National Electrical Code and or any other applicable national or local codes.
- For safety and proper performance this instrument must be connected to a properly grounded three-wire power source.
- Proper relay use and configuration is the responsibility of the user. No external connection to the instrument of more than 60VDC or 43V peak allowed with the exception of power and relay terminals. Any violation will impair the safety protection provided.
- Do not operate this instrument without front cover secured. Refer installation, operation and servicing to qualified personnel.



**⚠ DANGER**  
Live voltages may be present.  
Will cause severe injury or death.



**WARNING**  
RISK OF ELECTRICAL SHOCK



AC connections and grounding must comply with UL508 or local electrical code.  
Do not apply power to the analyzer until all electrical connections are verified and secure.



**WARNING**  
ELECTRICAL SHOCK HAZARD



Making cable connections to and servicing this instrument require access to shock hazard level voltages which can cause death or serious injury, therefore, disconnect all hazardous voltage before accessing the electronics.



**CAUTION**  
Ground conduit to metal stiffener or to metal enclosure. Use non-flammable watertight conduit fitting/plugs to preserve enclosure rating.



**CAUTION**  
For continued protection against fire, replace only with fuses of specified voltage and current ratings. Fuses are located under this cover.

Visit our website at [www.pnikorea.com](http://www.pnikorea.com)



**WATERZONE<sup>®</sup>**



**PNi Technology**  
41-16, Guro 5-Dong, Guro-Gu, Seoul KOREA  
Tel : 82-2-866-1803  
Fax : 82-2-866-1807  
E-mail : [pni@pnikorea.com](mailto:pni@pnikorea.com)

Section Title	TABLE OF CONTENTS	Page
<b>1.0 SPECIFICATIONS</b> .....		1
1.1 Features and Applications .....		1
1.2 Specifications .....		2
1.3 Ordering Information .....		3
<b>2.0 INSTALLATION</b> .....		4
2.1 Unpacking and Inspection .....		4
2.2 Installation .....		4
<b>3.0 WIRING</b> .....		6
3.1 General .....		6
3.2 Power, Alarm, Sensor and Output Wiring .....		6
<b>4.0 DISPLAY AND OPERATION</b> .....		8
4.1 General Description .....		8
4.2 Display .....		8
4.3 Key Functions and Controls .....		8
4.4 Alarm Status .....		9
<b>5.0 SOFTWARE CONFIGURATION</b> .....		10
5.1 Changing Alarm Setpoints .....		10
5.2 Ranging the Outputs .....		10
5.3 Changing Other's Parameters .....		11
5.4 Testing Output Current .....		12
5.5 Choosing Display Options .....		12
<b>6.0 CALIBRATION - FREE CHLORINE</b> .....		13
6.1 Introduction .....		13
6.2 Zeroing the Sensor .....		13
6.3 Full Scale Calibration .....		14

## 1.0 SPECIFICATIONS

### 1.1 FEATURES AND APPLICATIONS

The WATERZONE® Model WZ-RC300/310 Analyzer/Controller with the appropriate sensor monitors and controls free chlorine(ppm level) in a variety of process liquids.

Model WZ-RC300 are 1channel measurement, WZ-RC310 are 2channel measurement.

The analyzer is compatible with PNI Technology RS-500 series galvanic sensors for free chlorine. The galvanic sensors used with the Model WZ- RC300/310 produce a current directly proportional to the concentration of the substance being determined. Sensor currents are in the microampere range.

The Model WZ- RC300/310 Analyzer/Controller fully compensates free chlorine readings for changes in electrode signal caused by temperature changes.

The analyzer has a DIN144 size, dustproof enclosure of ABS resin. It is suitable panel mounting.

Programming and calibration are through the front membrane keypad, which has tactile feedback.

The 110\*84mm large back-lit custom liquid crystal module display shows the main measurement free chlorine, temperature in large numerals. The 4~20mA output current are shown in smaller numerals on the third line.

Two galvanically isolated outputs provide 4-20mA signals for free chlorine, temperature.

The Model WZ- RC300/310 Analyzer/Controller has two or four programmable alarm relays. Alarms can be assigned to the free chlorine measurements.

Alarms have programmable high or low activation, independent set-points, adjustable hysteresis dead-band.

## 1.2 SPECIFICATIONS - GENERAL

Model	: WZ-RC300/310 Residual Chlorine Transmitter
Measuring Method	: Galvanic Electrode Method
Measuring Range	: 0 10.00ppm,mg/L (Resolution 0.01ppm,mg/L) : -20.0 120.0°C (Resolution 0.1°C)
Display	: 110*84mm Back-lit Custom Liquid Crystal Module : Free Residual Chlorine, Temperature : High, Low Relay status & Message : Bar graph for Output Percent, image icons : 4~20mADC Output Value
Calibration	: against grab sample analyzed using portable test kit.
Temp' Compensation	: automatic between 0 and 50°C (Pt1000ohm RTD)
Repeatability	: 0.1% of Full Scale
Stability	: 0.1% of Full Scale / week
Response Time	: 20sec (90% Saturation)
Operating Temperature	: -10 75°C
Relative Humidity	: 90% (maximum) non-condensing
Current Output	: 2Chanel Isolated 4 20mADC (Resistance Load: Less then 750 )
Alarm Contact	: 1 or 2Chanel HIGH, LOW 250VAC 0.5A SPST
Power Source	: AC 110/220V 50/60Hz ±10%, approx. 3Watt
Enclosure	: DIN144 size 144(W) * 144(H) * 115(D)mm ABS resin : Window – Glass : Keypad –Membrane 6-Key with tactile feedback : Indoor, Dustproof
Installation	: Panel Mounting
Weight/Shipping Weight	: Approx. 2.0kg / 2.5kg
Recommended sensor	: RS-500-ATC, RS-500
Recommended Holder	: RH-1000, RH-1000C (Cleaning type)
Measuring Condition	: Conductivity = Min 100us/cm : Sampling Flow Rate = 0.5~1Liter per minute : Recommended Operation pH = 6 to 8pH

### 1.3 ORDERING INFORMATION

The Model WZ-RC300/310 Analyzer/Controller measures 1 or 2channel free chlorine. Galvanic measurements are fully compensated for changes in free chlorine with temperature. Standard features include a three-line back-lit LCD display, dual isolated outputs, and two or four programmable alarm relays. RS-485 communications control are optional.

WZ-	WATERZONE® Analyzer/Controller							
	Model Number							
	RC300 ▶ 1Channel Residual Chlorine Transmitter							
	RC310 ▶ 2Channel Residual Chlorine Transmitter							
	Measuring Range (ppm,mg/L)							
	1. 0 ~ 1		2. 0 ~ 2		3. 0 ~ 3			
	4. 0 ~ 4		5. 0 ~ 5		6. 0 ~ 10			
	U. User Ordering Spec'( )							
	Power Supply							
	1. AC 110V 50/60 Hz							
	2. AC 220V 50/60 Hz							
	Current Output Signal							
	1. One 4 ~ 20mA DC Analog Output							
	2. Two 4 ~ 20mA DC Analog Outputs							
	U. User Ordering Spec( )							
	Integral Temperature Compensator							
	N. None		1. Pt 1000 ohm					
	U. User Ordering Spec'( )							
	Cleaner Contact							
	1. None							
	2. Ultrasonic Cleaning							
	Mounting Method							
	1. 2inch Pipe Mount							
	2. Wall Mount							
WZ-	RC3X0	6	2	2	1	N	1	Continued (RC Sensor & Holder)

When place an order, selected ordering number should be indicated on the purchase order sheet

## 2.0 INSTALLATION

### 2.1 UNPACKING AND INSPECTION

Inspect the shipping container. If it is damaged, contact the shipper immediately for instructions. Save the box. If there is no apparent damage, unpack the container. Be sure all items shown on the packing list are present. If items are missing, notify PNI Technology representative immediately.

### 2.2 INSTALLATION

#### 2.2.1 General information

- Although the Analyzer/Controller is suitable for indoor use, do not install it in direct sunlight or in areas of extreme temperatures.
- Install the Analyzer/Controller in an area where vibrations and electromagnetic and radio frequency interference are minimized or absent.
- Keep the Analyzer/Controller and sensor wiring at least one foot from high voltage conductors. Be sure there is easy access to the Analyzer/Controller.
- The Analyzer/Controller is suitable for panel mounting. Refer to below.

#### 2.2.2 Front Dimensional Drawing

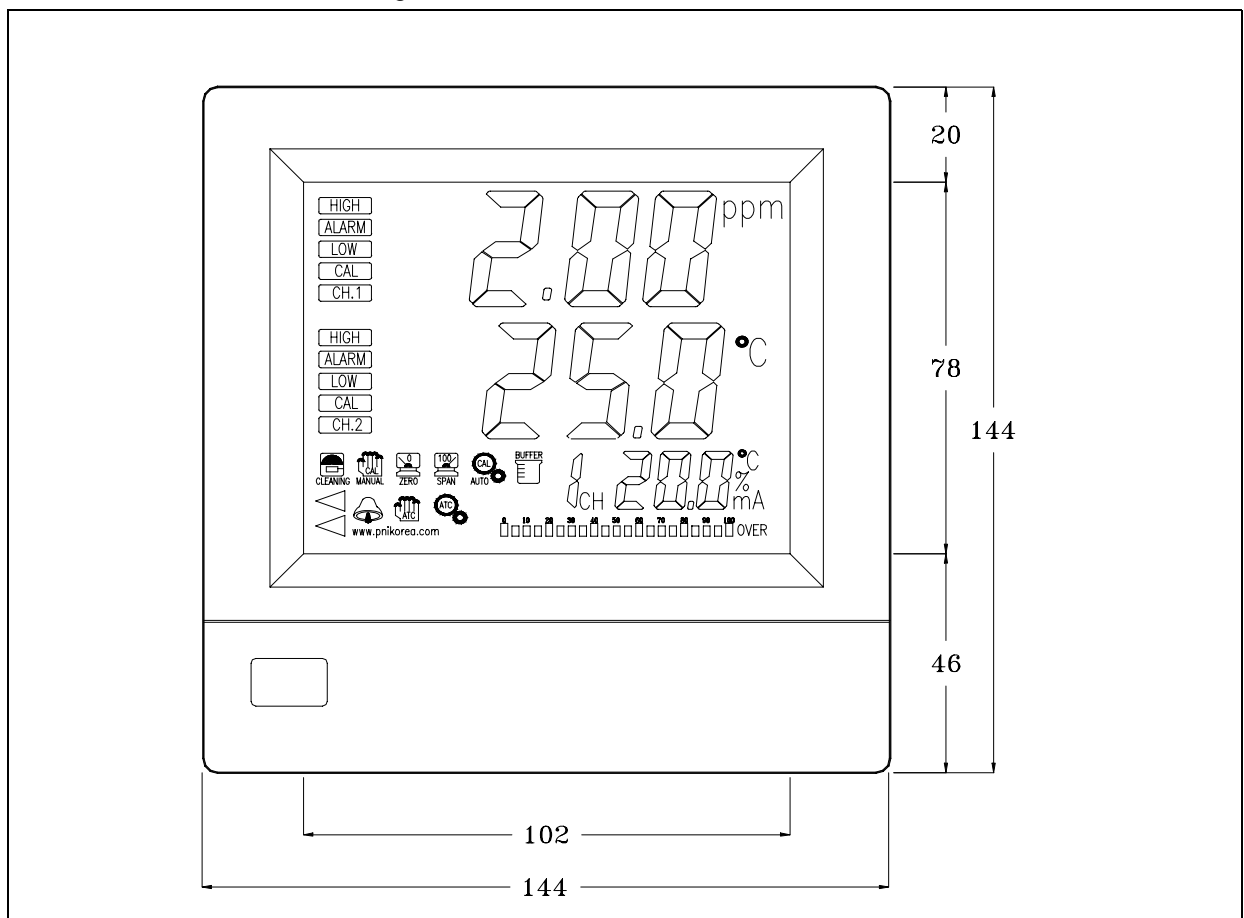

Figure 2-1. Front Dimensional Drawing



2.2.3 Side Dimensional Drawing

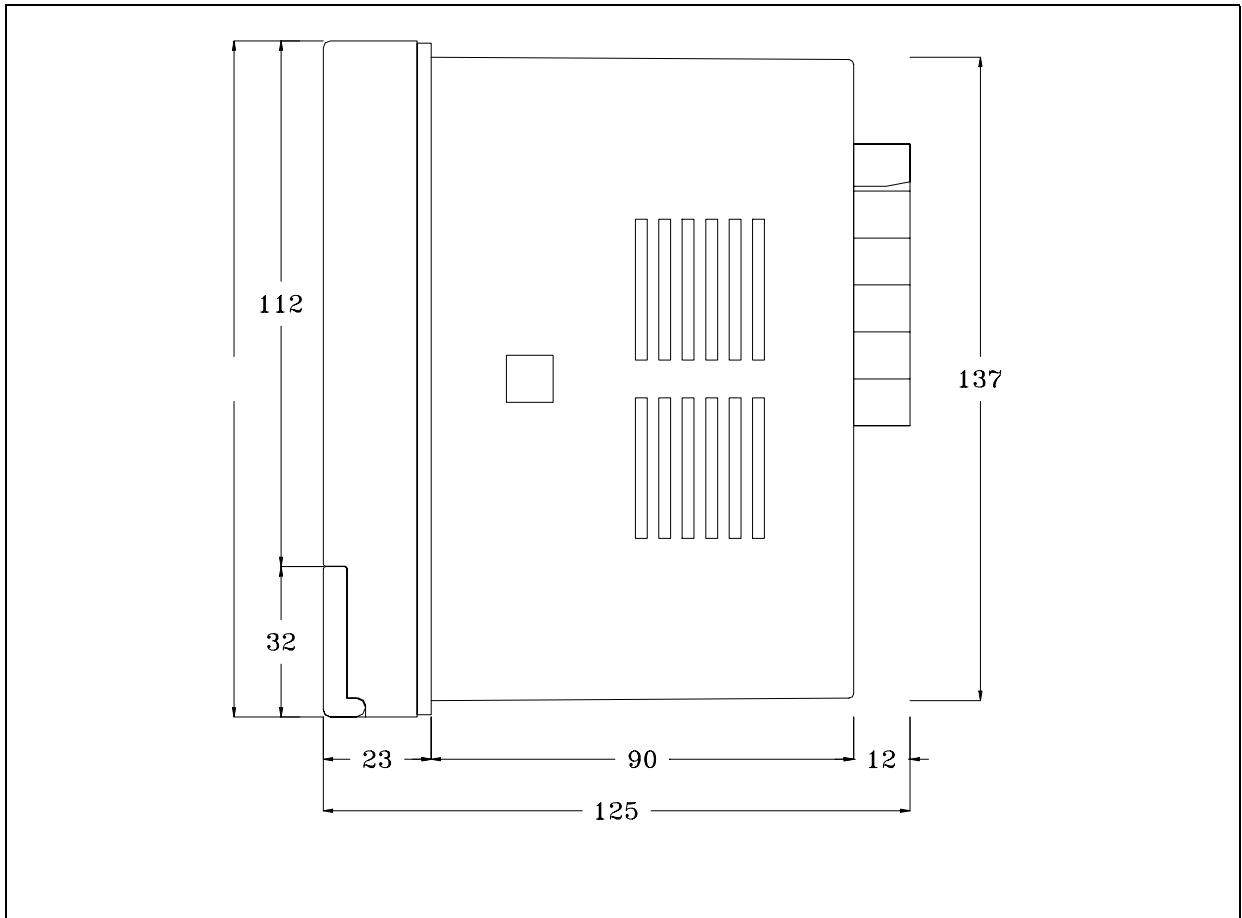

Figure 2-2. Side Dimensional Drawing

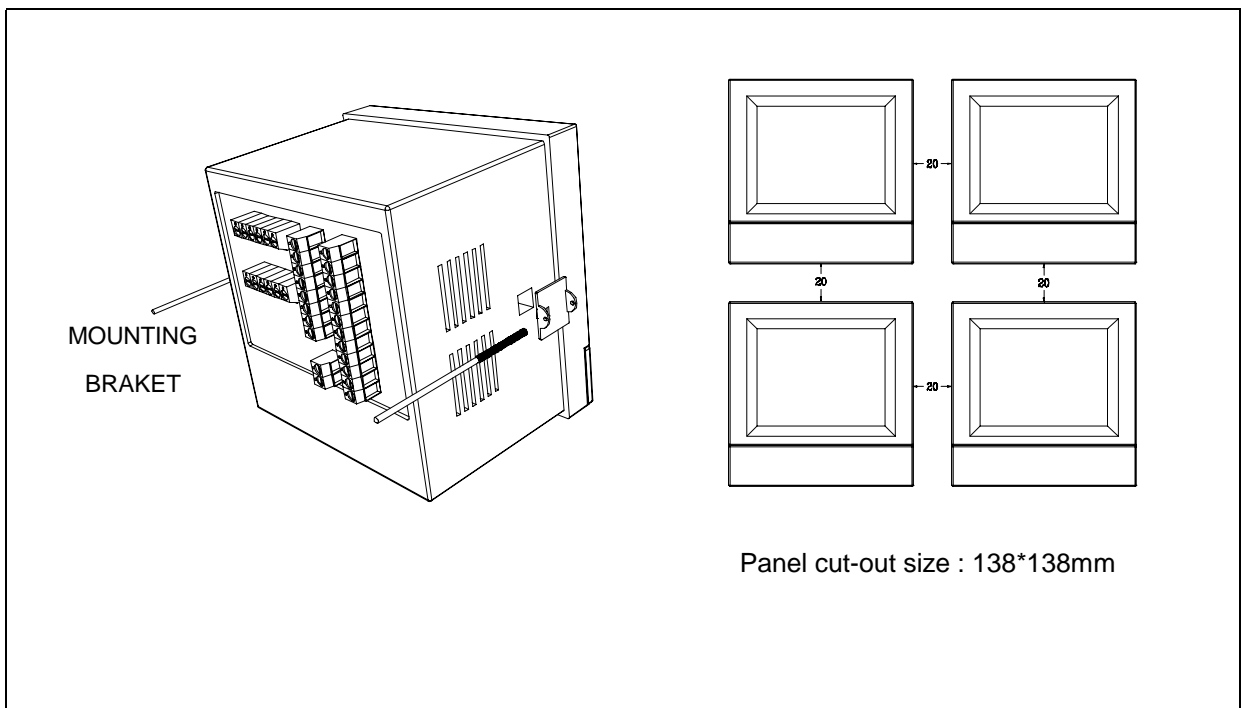

Figure 2-3. Side Dimensional Drawing

### 3.0 WIRING

**NOTE** Operating the analyzer and sensor for longer than five minutes while the analyzer is improperly configured will greatly increase the stabilization time for the sensor. Be sure to turn off power to the analyzer before wiring the sensor.

#### 3.1 GENERAL

**WARNING** Electrical installation must conform to the National Electrical Code, all state and local codes, and all plant codes and standards for electrical equipment. Electrical installation and wiring must be done by qualified personnel.

The rear side are for power and alarm relay, sensor, analog output wiring.

#### 3.2 POWER, ALARM, SENSOR AND OUTPUT WIRING

**DANGER** Live voltages may be present. Will cause severe injury or death.

Refer to Figure 3-1. Make power, alarm and analog output wiring connections on COMMON TERMINAL BLOCK. Make sensor input wiring connections on INPUT TERMINAL BLOCK.

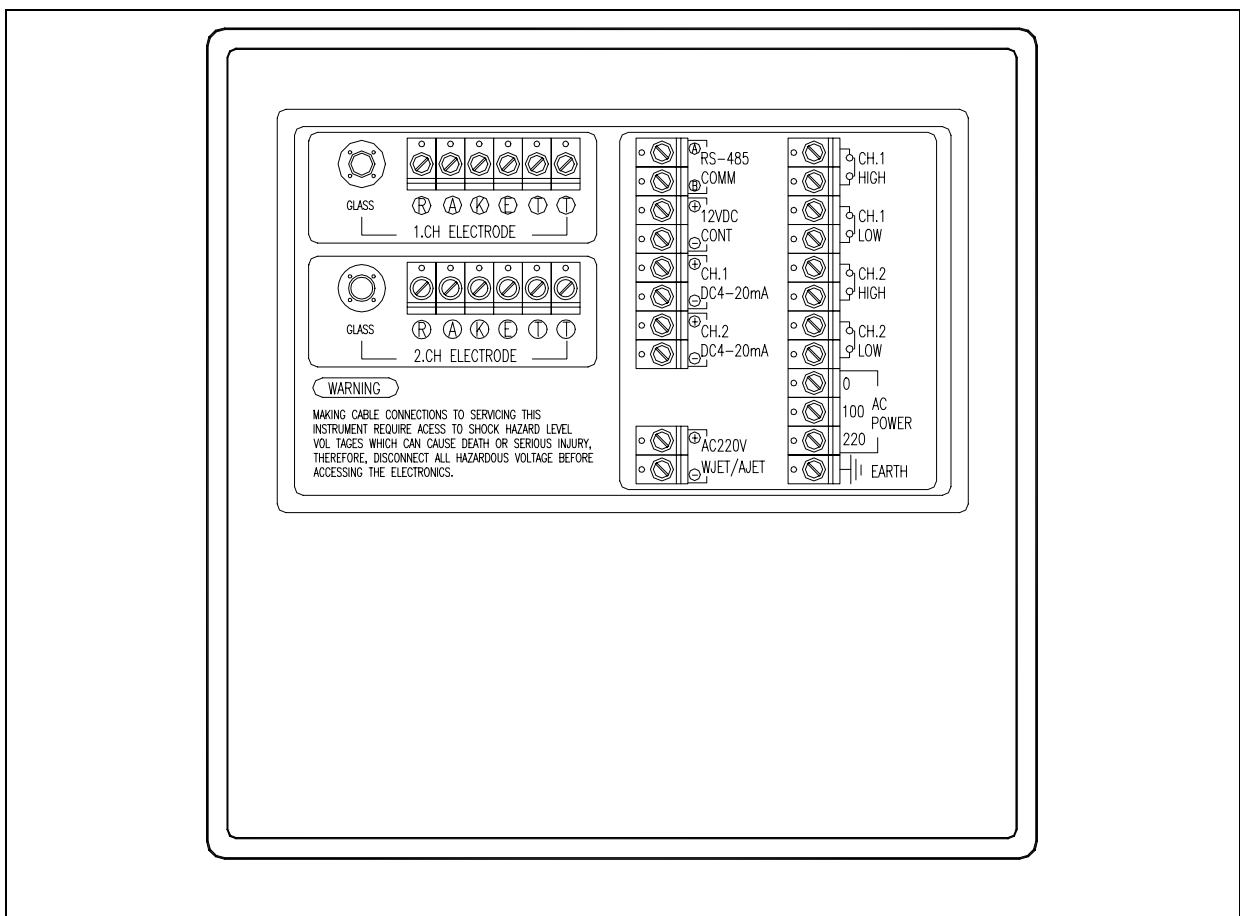

Figure 3-1. Power, Alarm, Sensor and Output Wiring

3.2 POWER, ALARM, SENSOR AND OUTPUT WIRING (CONTINUED)

**WARNING:** RISK OF ELECTRICAL SHOCK

AC connections and grounding must comply with UL 508 or local electrical code. DO NOT apply power to the analyzer until all electrical connections are verified and secure.

CH.1 high, low and CH.2 high, low alarm contacts are dry (i.e., not powered) and are normally open. 220V SAMPLE WJET are time controlled AC220V 0.2A output capability and are normally open. (Water-jet, Air-jet cleaning for pH, ORP, Dissolved Oxygen and other's measuring systems. This model is not used).

For best EMI/RFI protection, shield the output cable and enclose it in an earth-grounded, rigid, metal conduit. Keep sensor and output signal wiring separate from power wiring. Do not run sensor and power cables in the same conduit or close together in a cable tray.

AC wiring must be AWG18~22. Be sure to connect earth ground from the power cable to the nearby ground lug. A good earth ground is necessary for proper operation of the controller.

Provide a switch or breaker to disconnect the analyzer from the main power supply. Install the switch or breaker near the analyzer and label it as the disconnecting device.

- Wiring RS-500-ATC sensors for 1 or 2Channel free chlorine measurements.

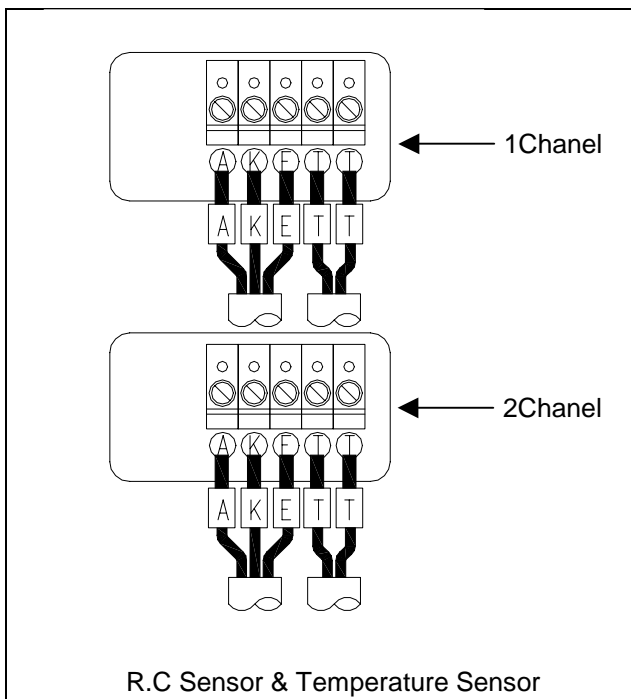

Figure 3-2. Sensor's Wiring Detail

Free chlorine is being measured and the pH of the liquid varies more than 0.2pH, a continuous correction for pH must be applied to the free chlorine reading. Recommended our product model WZ-PR310.

Figure 3-2 gives wiring diagrams for the 2Channel sensors typically used.

Manual temperature compensation mode at unconnected temperature Sensor.

Temperature Sensor is Pt1000 Ohms RTD.

## 4.0 DISPLAY AND OPERATION

### 4.1 GENERAL DESCRIPTION

The model WZ-RC300/310 Analyzer/Controller is a 1 or 2channel free chlorine input, dual 4~20mADC output instrument. Figure 4-1 shows how the instrument inputs and outputs can be configured for free chlorine.

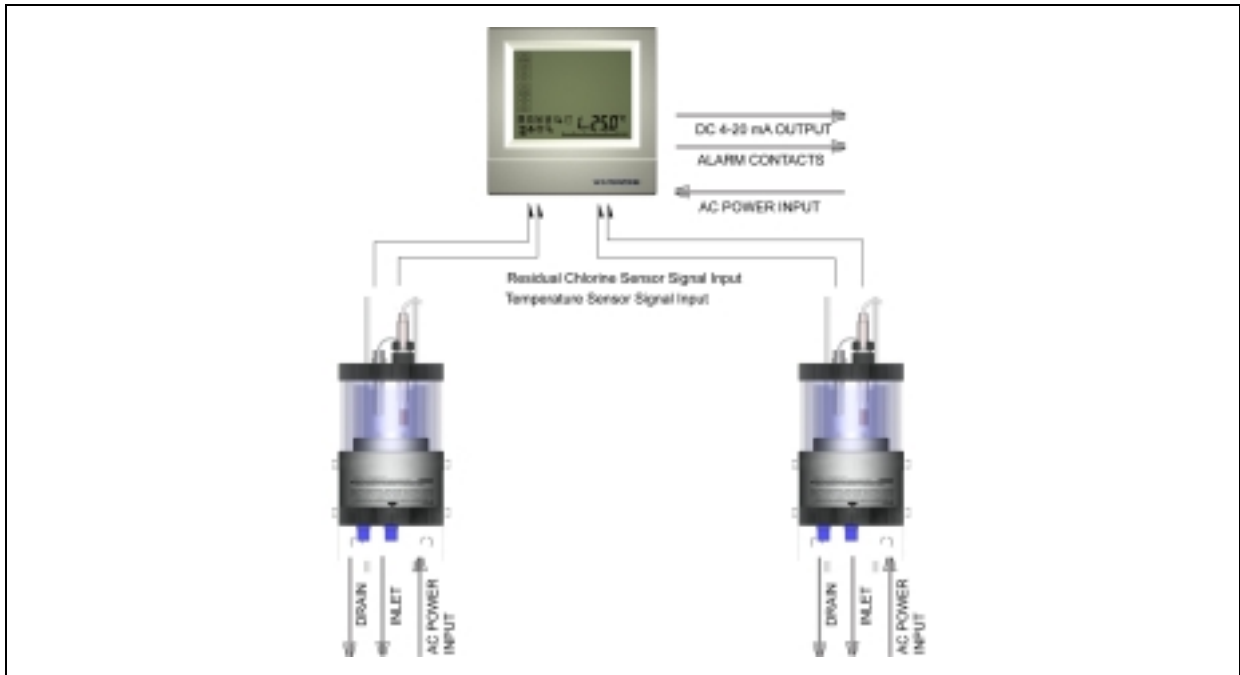

Figure 4-1 System Diagram

### 4.2 DISPLAY



Figure 4-2 Main Normal Display

Figure 4-2 shows the MODEL WZ-RC310 main Normal display.

The free chlorine is always displayed continuously in large numerals. The temperature are displayed on the third line of the main display. Bar-graph are show the output current percent.

### 4.3 KEY FUNCTIONS AND CONTROLS



Figure 4-3 Membrane Keypad

Figure 4-3 shows the Membrane Keypad.

Keypad is membrane 6-Key with tactile feedback.

The keys labeled MODE, SHIFT, UP, ENTER, CAL, ESC are normal key. Added SHIFT+ UP key are FUNCTION key.

## 4.3 KEY FUNCTIONS AND CONTROLS (CONTINUED)



Press MODE key to access a set parameter.

Press FUNCTION (SHIFT+ UP) key to change a chanel.1 or chanel.2 set parameter.

Mode.1 HI.A : This mode are display and setting the HIGH alarm point.

Mode.2 LO.A : This mode are display and setting the LOW alarm point.

Mode.3 HyS : This mode are display and setting the alarm hysteresis.

Mode.4 L.Ot : This mode are display and setting the low output current point.

Mode.5 H.Ot : This mode are display and setting the high output current point.

Mode.6 Hd.t : This mode are display and setting the value of manual temperature compensation.

Mode.7 dP.t : This mode are display and setting the average time of measuring .

Mode.8 P.Hr : This mode are display and setting the cleaning period hour time.  
Water-jet, Air-jet cleaning time for pH, ORP, Dissolved Oxygen and other's measuring systems. This model is not used.

Mode.9 C.tt : This mode are output current test.

Press FUNCTION (SHIFT+ UP) key to execute a output current test.

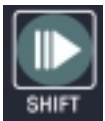

To change a number or a setting press this key. Use the SHIFT key to move the cursor right to the desired set digit. Press with UP key are use the FUNCTION key.

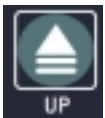

To change a number or a setting press this key. Use the UP key to increase the desired set digit. Press with SHIFT key are use the FUNCTION key.

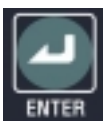

To store a number or setting in memory, press ENTER key.

After press ENTER key to access a next set parameter.

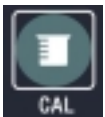

To zeroing and slope calibration, press continuous 5second CAL key.

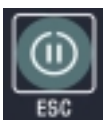

To leave without storing changes, and return to the main normal display, press ESC key.

## 4.4 ALARM STATUS



LCD icons indicate when alarm relays chanel.1 high, low and chanel.2 high, low are energized.

## 5.0 SOFTWARE CONFIGURATION

### 5.1 CHANGING ALARM SETPOINTS

#### 5.1.1 Changing High Alarm Setpoint



- Press MODE key and move the parameter to the desired Mode.1 high alarm. The H.A are displayed on the third line.
- Use the UP key to increase a digit.
- Use the SHIFT key to move the cursor right.
- To store a setting in memory, press ENTER key.
- To leave without storing changes, press MODE or ESC key.

#### 5.1.2 Changing Low Alarm Setpoint



- Press MODE key and move the parameter to the desired Mode.2 low alarm. The L.A are displayed on the third line.
- Use the UP key to increase a digit.
- Use the SHIFT key to move the cursor right.
- To store a setting in memory, press ENTER key.
- To leave without storing changes, press MODE or ESC key.

#### 5.1.3 Changing Alarm Hysteresis



- Press MODE key and move the parameter to the desired Mode.3 alarm hysteresis. The HyS are displayed on the third line.
- Use the UP key to increase a digit.
- Use the SHIFT key to move the cursor right.
- To store a setting in memory, press ENTER key.
- To leave without storing changes, press MODE or ESC key.

### 5.2 RANGING THE OUTPUTS

#### 5.2.1 Low Ranging the Output



- Press MODE key and move the parameter to the desired Mode.4 low ranging the output. The L.Ot are displayed on the third line.
- Use the UP key to increase a digit.
- Use the SHIFT key to move the cursor right.
- To store a setting in memory, press ENTER key.
- To leave without storing changes, press MODE or ESC key.

## 5.2.2 High Ranging the Output



- Press MODE key and move the parameter to the desired Mode.5 high ranging the output. The H.O.t are displayed on the third line.
- Use the UP key to increase a digit.
- Use the SHIFT key to move the cursor right.
- To store a setting in memory, press ENTER key.
- To leave without storing changes, press MODE or ESC key.

## 5.3 CHANGING OTHER'S PARAMETERS

### 5.3.1 Setting the Manual T.C



- Press MODE key and move the parameter to the desired Mode.6 manual temperature compensation. The Hd.t are displayed on the third line. (CH.1 only)
- Use the UP key to increase a digit.
- Use the SHIFT key to move the cursor right.
- To store a setting in memory, press ENTER key.
- To leave without storing changes, press MODE or ESC key.

### 5.3.2 Setting the Average Time



- Press MODE key and move the parameter to the desired Mode.7 average time of measuring. The dP.t are displayed on the third line.
- Use the UP key to increase a digit.
- Use the SHIFT key to move the cursor right.
- To store a setting in memory, press ENTER key.
- To leave without storing changes, press MODE or ESC key.

### 5.3.3 Setting the Cleaning Period Time



- Press MODE key and move the parameter to the desired Mode.8 cleaning period time. The P.Hr are displayed on the third line.
- Water-jet, Air-jet cleaning period time for pH, ORP, Dissolved Oxygen and other's measuring systems. This model is not used.

## 5.4 TESTING OUTPUT CURRENT



- Press MODE key and move the parameter to the desired Mode.9 testing output current. The C.t.t are displayed on the third line.
- Press FUNCTION (SHIFT+ UP) key to access a output current. The YES to OUt are displayed on the second line.
- Use the UP key to increase a digit.
- Use the SHIFT key to move the cursor right.
- Test range are 0~125.0%.
- To leave without test, press MODE or ESC key.

## 5.5 CHOOSING DISPLAY OPTIONS

### 5.5.1 Setting the Measuring Unit



- Press ESC key and return to the Main Normal Display.
- Press continuous 5second ENTER key to the changes measuring unit. The mg/L to ppm, ppm to mg/L are displayed on the first line.
- Store a setting in memory.



## 6.0 CALIBRATION - FREE CHLORINE

### 6.1 Introduction

Free chlorine sensor generates a current directly proportional to the concentration of free chlorine in the sample. Calibrating the sensor requires exposing it to a solution containing no chlorine (zero standard) and to a solution containing a known amount of chlorine (full-scale standard). The zero standard is necessary because chlorine sensors, even when no chlorine is in the sample, generate a small current called the residual current. The analyzer compensates for the residual current by subtracting it from the measured current before converting the result to a chlorine value. New sensors require zeroing before being placed in service. Either of the following makes a good zero standard.

- *Expose distilled water to bright sunlight for at least 2 hours.*
- *Deionized water containing about 500 ppm sodium chloride. Dissolve 0.5 grams (1/8 teaspoonful) of table salt in 1 liter of water. Do not use deionized water alone for zeroing the sensor. The conductivity of the zero water must be greater than 50  $\mu\text{S}/\text{cm}$ .*
- *Tap water known to contain no chlorine. Expose tap water to bright sunlight for at least 24 hours.*

The purpose of the full-scale standard is to establish the slope of the calibration curve. Because stable chlorine standards do not exist, the sensor must be calibrated against a test run on a grab sample of the process liquid. Several manufacturers offer portable test kits for this purpose. Observe the following precautions when taking and testing the grab sample.

- *Take the grab sample from a point as close to the sensor as possible. Be sure that taking the sample does not alter the flow of the sample to the sensor. It is best to install the sample tap just downstream from the sensor.*
- *Chlorine solutions are unstable. Run the test immediately after taking the sample. Try to calibrate the sensor when the chlorine concentration is at the upper end of the normal operating range.*

### 6.2 Zeroing the Sensor

Place the sensor in the zero standard. See Section 6.1. Be sure no air bubbles are trapped against the electrode. The sensor current will drop rapidly at first and then gradually reach a stable zero value. To monitor the measuring value, go to the main normal display. Do not start the zero routine until the sensor has been in zero solution for at least two hours.



- Press continuous 5second CAL key to the zero and full scale calibration. The manual cal, zero, span icons are displayed on the third line.
- Press ENTER key to access a calibration mode.
- Use the UP key to increase a digit.
- Use the SHIFT key to move the cursor right.
- Setting the 0.00 mg/L, ppm.
- Press ENTER key to measuring value flashes until the sensor is stabilized.
- Once the zero step is complete.
- Return to the main normal display.

### 6.3 Full Scale Calibration

Place the sensor in the process liquid. If automatic pH correction is being used, calibrate the pH sensor and place it in the process liquid. If manual pH correction is being used, measure the pH of the process liquid and enter the value. See Section 5.3. Adjust the sample flow is within the 0.5~1.0 l/min recommended for the chlorine sensor. Adjust the chlorine concentration until it is near the upper end of the control range. Wait until the analyzer reading is stable before starting the calibration.



- Press continuous 5second CAL key to the zero and full scale calibration. The manual cal, zero, span icons are displayed on the third line.
- Press ENTER key to access a calibration mode.
- Use the UP key to increase a digit.
- Use the SHIFT key to move the cursor right.
- Setting the known to contain free chlorine mg/L, ppm.
- Press ENTER key to measuring value flashes until the sensor is stabilized.
- Once the slope step is complete.
- Return to the main normal display.

# Model WZ-RC300/310

Water Quality Instrument for Process Management

WZ- RC300/310 Residual Chlorine Transmitter

## **PNI Technology**

41-16, KURO 5-DONG, KURO-KU, SEOUL KOREA

TEL : 82-2-866-1803

FAX : 82-2-866-1807

Visit our web-site : [www.pnikorea.com](http://www.pnikorea.com)



Physicalchemist And Instrument Technology For Process Management